

Nokia X5-01 User Guide

Issue 1.1

Contents

Write text	24
Search	26
Safety	5
About your device	5
Network services	7
Shared memory	7
About Digital Rights Management	7
1. Get started	9
Keys and parts	9
Insert SIM card and battery	10
Memory card	11
Antenna locations	12
Switch the device on and off	12
Charge the battery	13
Keypad lock (keyguard)	14
Volume control	15
Headset	15
Wrist strap	16
Copy content from your old device	16
Shortcuts	17
Ovi by Nokia	18
About Ovi Store	19
2. Your device	20
Device setup	20
Settings wizard	20
Home screen	20
Display indicators	22
3. Personalise your device	27
Profiles	27
Select ringing tones	28
Change the display theme	28
3-D ringing tones	28
4. Make calls	30
Make a call	30
Answer or reject a call	30
Voice mail	31
Make a conference call	31
Speed dial a phone number	32
Call waiting	32
Call divert	33
Call barring	34
Voice dialling	34
Make a video call	35
Answer or decline a video call	36
Internet calls	37
Video sharing	38
Call and data registers	41
5. Contacts	42
Stay connected with your online friends	42
Save and edit names and numbers	42
Manage names and numbers	42

Ringling tones, images, and call text for contacts	43	Video Centre	69
		RealPlayer	69
6. Messaging	44	9. Internet	71
About messaging	44	About Browser	71
Write and send messages	44	Browse the web	71
Check the number of unread messages	46	Browser toolbar	72
E-mail	47	Navigate pages	72
Nokia Messaging	49	Web feeds and blogs	73
About Chat	50	Bookmarks	73
Message reader	50	Empty the cache	74
Speech	51	End the connection	74
Messaging settings	52	Connection security	74
7. Music and audio	56	10. Time management	76
Music key	56	Calendar	76
Music player	56	Set time and date	78
Ovi Music	59	Alarm clock	78
Say and Play	60	11. Office applications	80
Nokia Podcasting	60	Active notes	80
FM Radio	62	Calculator	81
Internet radio	63	Converter	81
Recorder	64	Zip manager	82
		Dictionary	82
8. Images and videos	65	Notes	83
Camera	65	12. Connectivity	84
Gallery	66	Data connections and access points	84
Photos	67	Network settings	84
Share online	67		

4 Contents

Wireless LAN	85
Active data connections	88
Synchronisation	88
Bluetooth	89
Data cable	93
PC connections	93
About home network	94

13. Data management 95

Install or remove applications	95
File manager	97
Device manager	98
About Licenses	100

14. Settings 101

Application settings	101
Device and SIM card security	101
Accessory settings	101
Restore original settings	102

15. Find help 103

Support	103
Keep your device software up to date	103
In-device help	105
Settings	105
Access codes	106
Prolong battery life	107
Free memory	108

16. Green tips 109

Save energy	109
Recycle	109

Product and safety information 109

Index 118

Safety

Read these simple guidelines. Not following them may be dangerous or illegal. Read the complete user guide for further information.

SWITCH ON SAFELY



Do not switch the device on when wireless phone use is prohibited or when it may cause interference or danger.

ROAD SAFETY COMES FIRST



Obey all local laws. Always keep your hands free to operate the vehicle while driving. Your first consideration while driving should be road safety.

INTERFERENCE



All wireless devices may be susceptible to interference, which could affect performance.

SWITCH OFF IN RESTRICTED AREAS



Follow any restrictions. Switch the device off in aircraft, near medical equipment, fuel, chemicals, or blasting areas.

QUALIFIED SERVICE



Only qualified personnel may install or repair this product.

ACCESSORIES AND BATTERIES



Use only approved accessories and batteries. Do not connect incompatible products.

WATER-RESISTANCE



Your device is not water-resistant. Keep it dry.

About your device

The wireless device described in this guide is approved for use on the (E)GSM 850, 900, 1800, and 1900 MHz networks, and UMTS 900, 1900, and 2100 MHz HSDPA and HSUPA networks. Contact

your service provider for more information about networks.

Your device supports several connectivity methods and like computers may be exposed to viruses and other harmful content. Exercise caution with messages, connectivity requests, browsing, and downloads. Only install and use services and software from trustworthy sources that offer adequate security and protection, such as applications that are Symbian Signed or have passed the Java Verified™ testing. Consider installing antivirus and other security software on your device and any connected computer.

Your device may have preinstalled bookmarks and links for third-party internet sites and may allow you to access third-party sites. These are not affiliated with Nokia, and Nokia does not endorse or assume liability for them. If you access such sites, take precautions for security or content.



Warning:

To use any features in this device, other than the alarm clock, the device must be switched on. Do not switch the device on when wireless device use may cause interference or danger.

When using this device, obey all laws and respect local customs, privacy and legitimate rights of others, including copyrights. Copyright protection may prevent some images, music, and other content from being copied, modified, or transferred.

Make back-up copies or keep a written record of all important information stored in your device.

When connecting to any other device, read its user guide for detailed safety instructions. Do not connect incompatible products.

The images in this guide may differ from your device display.

Refer to the user guide for other important information about your device.

Network services

To use the device you must have service from a wireless service provider. Some features are not available on all networks; other features may require that you make specific arrangements with your service provider to use them. Network services involve transmission of data. Check with your service provider for details about fees in your home network and when roaming on other networks. Your service provider can explain what charges will apply. Some networks may have limitations that affect how you can use some features of this device requiring network support such as support for specific technologies like WAP 2.0 protocols (HTTP and SSL) that run on TCP/IP protocols and language-dependent characters.

Your service provider may have requested that certain features be disabled or not activated in your device. If so, these features will not appear on your device menu. Your device may also have customized items such as menu names, menu order, and icons.

Shared memory

The following features in this device may share memory: multimedia messaging (MMS), e-mail application, instant messaging, for example. Use of one or more of these features may reduce the memory available for the remaining features. If your device displays a message that the memory is full, delete some of the information stored in the shared memory.

About Digital Rights Management

When using this device, obey all laws and respect local customs, privacy and legitimate rights of others, including copyrights. Copyright protection may prevent you from copying, modifying, or transferring images, music, and other content.

Content owners may use different types of digital rights management (DRM) technologies to protect their intellectual property, including copyrights. This device uses various types of DRM software to access DRM-protected content. With this device you can access content protected with WMDRM 10 and OMA DRM 2.0. If certain DRM software fails to protect the

content, content owners may ask that such DRM software's ability to access new DRM-protected content be revoked. Revocation may also prevent renewal of such DRM-protected content already in your device. Revocation of such DRM software does not affect the use of content protected with other types of DRM or the use of non-DRM-protected content.

Digital rights management (DRM) protected content comes with an associated licence that defines your rights to use the content.

If your device has OMA DRM-protected content, to back up both the licence and the content, use the backup feature of Nokia Ovi Suite.

Other transfer methods may not transfer the licences which need to be restored with the content for you to be able to continue the use of OMA DRM-protected content after the device memory is formatted. You may also need to restore the licence in case the files on your device get corrupted.

If your device has WMDRM-protected content, both the licence and the content will be lost if the device memory

is formatted. You may also lose the licence and the content if the files on your device get corrupted. Losing the licence or the content may limit your ability to use the same content on your device again. For more information, contact your service provider.

Some licences may be connected to a specific SIM card, and the protected content can be accessed only if the SIM card is inserted in the device.

1. Get started

Keys and parts

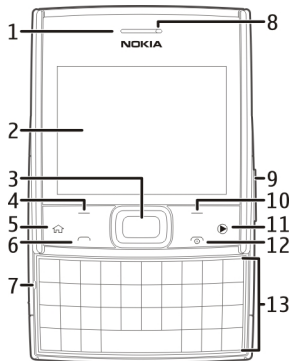

- 1 Ambient light sensor
- 2 Display
- 3 Navi™ key (scroll key)
- 4 Left selection key
- 5 Home key
- 6 Call key
- 7 Microphone
- 8 Earpiece
- 9 Volume/Zoom keys
- 10 Right selection key
- 11 Music key

- 12 End/Power key
- 13 Keyboard

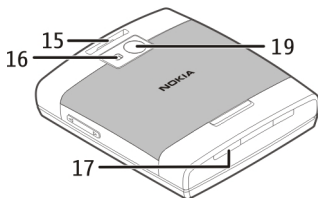
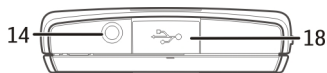

- 14 Nokia AV connector (3.5 mm)
- 15 Wrist strap hole
- 16 Camera flash
- 17 Loudspeaker
- 18 Micro USB/Charger connector
- 19 Camera lens

! **Note:** The surface of this device does not contain nickel in the platings. The surface of this device contains stainless steel.

During extended operation such as high speed data connection and extensive WLAN usage, the device may feel warm.

10 Get started

In most cases, this condition is normal. If you suspect the device is not working properly, take it to the nearest authorised service facility.

Insert SIM card and battery

Safe removal. Always switch the device off and disconnect the charger before removing the battery.

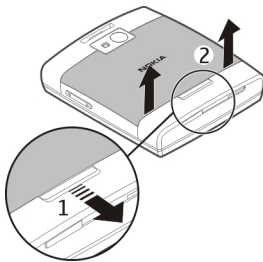

- 1 To release the back cover, pull and hold the release button.
- 2 While holding the release button, lift the back cover.

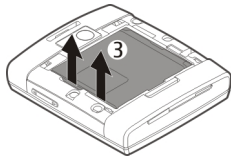

- 3 Remove the battery, if inserted.

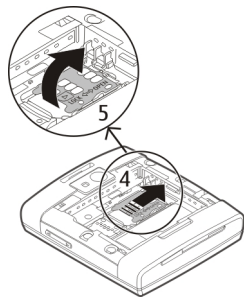

- 4 To unlock the SIM card holder, push it to the right.
- 5 Lift the SIM card holder up.

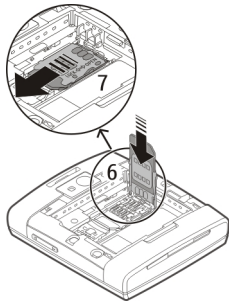

- 6 Slide the SIM card into the SIM card holder. Make sure the contact area of the card is facing down.
- 7 Push the holder down, and to lock it, push it to the left.

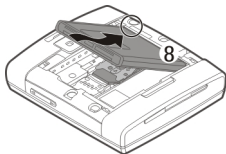

- 8 Line up the battery contacts with the battery compartment connectors, and insert the battery.
- 9 Replace the back cover.

Memory card

Use only compatible microSD cards approved by Nokia for use with this device. Nokia uses approved industry standards for memory cards, but some brands may not be fully compatible with this device. Incompatible cards may damage the card and the device and corrupt data stored on the card.

Insert a memory card

A memory card may already be inserted in the device. If not, do the following:

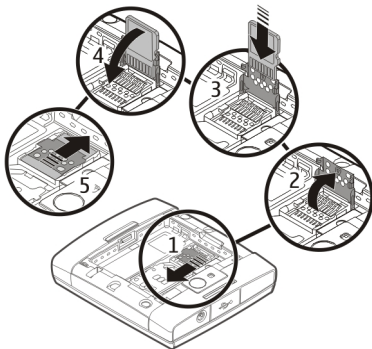

12 Get started

- 1 To release the memory card holder, push the holder to the direction indicated by the arrow on the holder.
- 2 Lift the memory card holder up.
- 3 Slide a compatible memory card into the memory card holder. Make sure the contact area of the card is facing down.
- 4 Push the memory card holder down.
- 5 To lock the memory card holder, push the holder to its original position.

Remove the memory card

- 1 Switch the device off.
- 2 Remove the back cover and the battery.
- 3 Remove the memory card from the memory card holder.

Antenna locations

Your device may have internal and external antennas. Avoid touching the antenna area unnecessarily while the antenna is transmitting or receiving. Contact with antennas affects the communication quality and may cause a higher power level during operation and may reduce the battery life.



Switch the device on and off

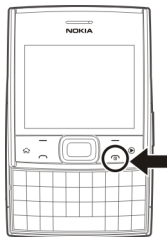

Press and hold the power key to switch the device on and off. Briefly pressing this key ends an active call or closes an application.

If the device asks for a PIN code, enter the PIN code, and select **OK**.

If the device asks for the lock code, enter the lock code, and select **OK**. The factory setting for the lock code is 12345.

To set the correct time zone, time, and date, select the country you are presently in, then enter the local time and date.

Charge the battery

Your battery has been partially charged at the factory, but you may need to recharge it before you can switch on your device for the first time.

If the device indicates a low charge, do the following:

- 1 Connect the charger to a wall outlet.
- 2 Connect the charger to the device.

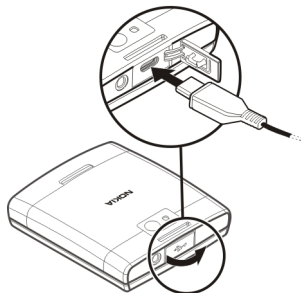

- 3 When the device indicates a full charge, disconnect the charger from the device, then from the wall outlet.

To avoid breaking the charger connector, be careful when connecting or disconnecting the charger cable.

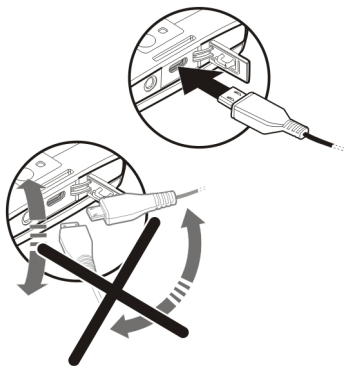

You do not need to charge the battery for a specific length of time, and you can use the device while it is charging. If the battery is completely discharged, it may take several minutes before the charging indicator appears on the display or before any calls can be made.

Charge over USB

- 1 Use a compatible USB cable to connect to a compatible device, such as a computer.
- 2 If your device is switched on, when prompted, select a USB mode.

If connected to a computer, you can synchronise your device while charging.

Charging over USB can take longer to start, and may not work if you connect through a non-powered USB hub. Your device charges more quickly when connected to a wall outlet.

Keypad lock (keyguard)

To unlock the keypad, open the slide, or select **Unlock**, then quickly select **OK**.

Select **Menu > Ctrl. panel > Settings and General**.

To set the device to lock the keypad when you close the slide, select **Slide handling > Keyguard activation**.

To set the device to automatically lock the keypad after a certain length of time, select **Security > Phone and SIM card > Keypad autolock period > User defined**, and select the desired time.

When the device or keypad is locked, calls may be possible to the official emergency number programmed into your device.

Volume control

To adjust the earpiece or loudspeaker volume during a call or when listening to an audio file, use the volume keys.

To activate or deactivate the loudspeaker during a call, select **Loudsp.** or **Options > Activate handset**.

Warning:

Continuous exposure to high volume may damage your hearing. Listen to music at a moderate level, and do not hold the device near your ear when the loudspeaker is in use.

Headset

You can connect a compatible headset or compatible headphones to your device. You may need to select the cable mode.

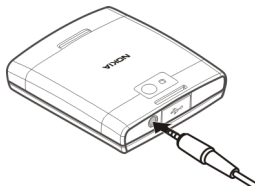

Warning:

When you use the headset, your ability to hear outside sounds may be affected. Do not use the headset where it can endanger your safety.

To make handsfree phone calls, use a headset with a compatible remote control unit, or use the microphone on the device.

To adjust the volume during a call, use the volume key on the device or, if available, on the headset. Some headsets have multimedia volume controls that can only be used to adjust the volume for music or video playback.

If you use a headset that is not approved by Nokia for use with this device, the sound quality may be poor.

Do not connect products that create an output signal as this may cause damage to the device. Do not connect any voltage source to the Nokia AV Connector.

When connecting any external device or any headset, other than those approved by Nokia for use with this device, to the Nokia AV Connector, pay special attention to volume levels.

Wrist strap

Thread the wrist strap, and tighten it.

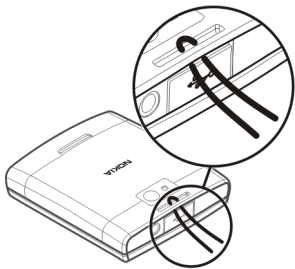

Copy content from your old device

You can use the Switch application to copy content such as phone numbers, addresses, calendar items, and images from your previous compatible Nokia device to your new device.



Copy content for the first time

- 1 To retrieve data from the other device for the first time, on your device, select **Menu > Ctrl. panel > Switch**.
- 2 Pair the two devices. To have your device search for devices with Bluetooth connectivity, select **Continue**. Select the device from which you want to transfer content. You are asked to enter a code on your device. Enter a code (1-16 digits), and select **OK**. Enter the

same code on the other device, and select **OK**. The devices are now paired.

If your old Nokia device does not have the Switch application, your new device sends it in a message. Open the message in the old device, and follow the instructions on the display.

- 3 On your device, select the content you want to transfer from the other device.

When the transfer has started, you can cancel it and continue later.

Content is transferred from the memory of the other device to the corresponding location in your device. The transfer time depends on the amount of data to be transferred.

The type of content that can be transferred depends on the model of the device from which you want to transfer content. If that device supports synchronisation, you can also synchronise data between the devices. Your device notifies you if the other device is not compatible.

Shortcuts

Here are some of the available keyboard shortcuts in your device. Shortcuts can make the use of the applications more efficient.

General shortcuts

Power key	Press and hold to switch your device on or off. Press once to close an application and go to the home screen.
Music key	Press once to open or hide Music player. Press and hold to go to the Music menu.
Home key	Press once to hide an application and go to the home screen, leaving the application open in the background. Press and hold to switch between open applications.

Sym key	In a text input field, press to insert a symbol or smiley.
---------	--

Home screen

Power key	Press once to switch between profiles.
Left selection key + right selection key	Unlock the keypad and keyboard.
Call key	Open the call log, or call a contact.
Home key	Open the main menu. Press and hold to switch between open applications.
0	Press and hold to start browsing the web.
1	Press and hold to call your voice mailbox.
Number key (2–9)	Call a phone number using speed dialling. To activate speed dialling,

	select Menu > Ctrl. panel > Settings and Phone > Call > Speed dialling.
Ctrl key	Press and hold to activate or deactivate the silent profile.
Sym key	Press and hold to activate or deactivate Bluetooth connectivity.
Space	Press and hold to switch the torch on or off.

Ovi by Nokia

 With Ovi by Nokia, you can find new places and services, and stay in touch with your friends. You can do, for example, the following:

- Download games, applications, videos, and ringtones to your device
- Get music

Some items are free of charge, others you may need to pay for.

The available services may also vary by country or region, and not all languages are supported.

To access Nokia's Ovi services, go to www.ovi.com, and register your own Nokia account.

For more information, go to the support section at www.ovi.com.

About Ovi Store

 With Ovi Store, you can download mobile games, applications, videos, pictures, themes, and ringing tones to your device. Some items are free of charge; others you need to pay for with your credit card or in your phone bill. The availability of payment methods depends on your country of residence and your network service provider. Ovi Store offers content that is compatible with your mobile device and relevant to your tastes and location.

2. Your device

Device setup

 With the Phone setup application, you can do the following, for example:

- Define the regional settings, such as the language of the device.
- Transfer data from your old device.
- Personalise your device.
- Set up your mail accounts.
- Sign up for the My Nokia service to receive free tips, tricks, and support for your Nokia device. You will also receive notifications when new software updates are available for your device.
- Activate Ovi services.

When you switch on your device for the first time, the Phone setup application opens. To open the application later, select **Menu > Applications > Help > Phone setup**.

Settings wizard

With Settings wizard, you can define e-mail and connection settings. The availability of the items in Settings wizard depends on the features of the

device, SIM card, service provider, and the data in the Settings wizard database.

Select **Menu > Ctrl. panel > Sett. wizard**.

To get the best results when using Settings wizard, keep your SIM card inserted in the device. If the SIM card is not inserted, follow the instructions on the display.

Select from the following:

Operator — Define the operator-specific settings, such as MMS, internet, WAP, and streaming settings.

E-mail setup — Configure a POP, IMAP, or Mail for Exchange account.

Video sharing — Configure video sharing settings.

The settings available for editing may vary.

Home screen

About home screen

The home screen is your starting point where you can collect all your important contacts and application shortcuts.

When you have switched on the device, and it is registered to a network, the device is in the home screen view.

Use the scroll key to navigate in the home screen.

Depending on your home screen theme, your home screen may include the following:

- Contacts bar
- Application plug-ins
- Application shortcuts
- Notification area

To customise application plug-ins and shortcuts, or to change the home screen theme, select **Menu > Ctrl. panel > Settings and General > Personalisation > Standby mode** and the appropriate option. You may not be able to change all shortcuts.

Search for contacts in the home screen

- 1 To search for contacts in the home screen, start entering the contact's first or second name. Select the desired contact from the proposed

matches. This feature may not be available in all languages.

- 2 To call the contact, press the call key.

To deactivate the contact search, select **Options > Contact search off**.

About contacts bar

You can add several contacts directly to the home screen, and quickly make calls or send messages to the contacts, view the contacts' web feeds, or access the contact information and settings.

Contacts bar

To add a contact to your home screen, select the Add contact icon and a contact from the list.

To create a new contact, select **Options > New contact**, enter the details, and select **Done**. You can also add an image to the contact information.

To add a web feed for a contact, select the Add feed icon, the desired feed from the list, and **Done**.

To create a new feed, select **Options** > **New feed**.

To update a feed, select **Refresh**.

To remove a contact from the home screen, in the contact information view, select the Settings icon and **Remove**.

Display indicators



The device is being used in a 3G network or a GSM network (network service). The bar next to the icon indicates the signal strength of the network at your current location. The higher the bar, the stronger the signal.

3.5G High-speed downlink packet access (HSDPA) / high-speed uplink packet access (HSUPA) (network service) in the 3G network is activated.



You have activated the offline profile, and the device is not connected to a cellular network.



The battery charge level. The higher the bar, the more charge remains in the battery.



You have unread messages in the Inbox folder in Messaging. If the indicator is blinking, your Inbox is full and you need to remove old messages from the Inbox before you can receive new messages.



You have received new e-mail in the remote mailbox.



There are messages waiting to be sent in the Outbox folder in Messaging.



You have missed calls.





















The keys of the device are locked.





An alarm is active.



You have activated the silent profile, and the device does not ring for an incoming call or message.

-  Bluetooth connectivity is activated. indicates that the connection is active.  indicates that the connection is on hold.
-  A Bluetooth connection is established. When the indicator is blinking, your device is trying to connect with another device.  You have set the device to scan for wireless LANs (WLAN), and a WLAN is available.
-  A GPRS packet data connection is available (network service).  indicates that the connection is active.  indicates that the connection is on hold.  A WLAN connection is active in a network that does not have encryption.
-  An EGPRS packet data connection is available (network service).  indicates that the connection is active.  indicates that the connection is on hold.  A WLAN connection is active in a network that has encryption.
-  Your device is connected to a computer with a USB data cable.
-  A 3G packet data connection is available (network service).  indicates that the connection is active.  indicates that the connection is on hold. **2** The second phone line is being used (network service).
-  All calls are forwarded to another number. If you have two phone lines, a number indicates the active line.
-  HSDPA/HSUPA is supported and available (network service). The icon may vary between regions.  A headset is connected to the device.

 A hands-free car kit is connected to the device.

 Your device is synchronising.

Other indicators may also be displayed.

Write text

The available input methods may vary.

Use the keyboard

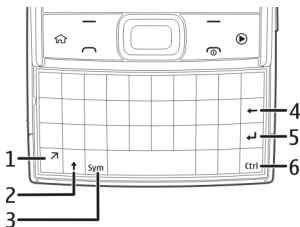

- 1 Function key
- 2 Shift key
- 3 Sym key
- 4 Backspace key
- 5 Enter key
- 6 Ctrl key

Switch between the different character cases

To change between the upper and lower case modes, press the shift key twice. To enter a single upper case letter in lower case mode, or vice versa, press the shift key once, and then the desired alphabet key.

Insert a number or special character printed at the top of a key

Press the function key, and then press the corresponding alphabet key, or press and hold the alphabet key only. To enter several special characters in a row, press the function key twice quickly, and then press the desired alphabet keys. To return to normal mode, press the function key once.

Insert a special character that is not on the keyboard

Press the sym key, and select  and a character.

Insert a letter that is not on the keyboard

It is possible to insert variations of letters, for example, letters with accents. For example, to insert á, press and hold the sym key, and

simultaneously press the A key repeatedly, until the desired character is displayed. The order and availability of letters depends on the selected writing language.

Insert a smiley

Press the sym key, and select a smiley. Smileys are only available for text and multimedia messages.

Tip: To add a recently used special character, while pressing and holding the ctrl key, press the sym key, and from the pop-up menu, select the character.

Copy and paste text

- 1 Press and hold the shift key, and scroll to highlight the text you want to copy.
- 2 Press **ctrl + C**.
- 3 Go to the place where you want to paste the text, and press **ctrl + V**.

Change the writing language or activate predictive text input

Select **Options > Input options**.

Predictive text input

To activate predictive text input, select **Options > Input options > Activate prediction**. The indicator  is displayed.

When you start writing a word, your device suggests possible words. When the correct word is found, scroll right to confirm it.

While writing, you can also scroll down to access a list of suggested words. If the desired word is on the list, select the word.

If the word you are writing is not in the dictionary of the device, the device suggests a possible word, while the word you were writing is shown above the suggested word. Scroll up to select your word. The word is added to the dictionary when you start writing the next word.

To deactivate predictive text input, select **Options > Input options > Deactivate prediction**.

To define the settings for text input, select **Options > Input options > Settings**.

To change the writing language, select **Options > Input options > Writing language**.

Search

Start a search

Select **Menu > Applications > Search**.

To search the contents of your mobile device, enter search terms in the search field, or browse the content categories. While you enter the search terms, the results are organised into categories. The most recently accessed results appear at the top of the result list, if they match your search terms.

3. Personalise your device

Profiles

Select **Menu > Ctrl. panel > Profiles.**

You can adjust and customise the ringing tones, alert tones, and other device tones for different events, environments, or caller groups. The active profile is shown at the top of the display in the home screen. However, if the active profile is General, only today's date is shown.

To create a new profile, select **Options > Create new**, and define the settings.

To customise a profile, select a profile and **Options > Personalise.**

To activate a profile, select a profile and **Options > Activate.**

To set the profile to be active until a certain time within the next 24 hours, scroll to the profile, select **Options > Timed**, and set the time. When the time expires, the profile changes back to the previously active non-timed profile. When the profile is timed,  is

displayed in the home screen. The Offline profile cannot be timed.

To delete a profile that you created, select **Options > Delete profile.** You cannot delete the predefined profiles.

When the Offline profile is activated, your connection to the cellular network is closed. All radio frequency signals between the device and the cellular network are prevented. If you try to send a message, it is placed in the Outbox folder, and is sent only when another profile is activated.

You can also use your device without a SIM card. If you remove the SIM card, the Offline profile is activated.

 **Important:** In the Offline profile you cannot make or receive any calls, or use other features that require cellular network coverage. Calls may still be possible to the official emergency number programmed into your device. To make calls, you must first activate the phone function by changing profiles. If the device has been locked, enter the lock code.

When you use the Offline profile, you can still use a wireless LAN (WLAN), for example, to read your mail or browse the internet. You can also use Bluetooth connectivity. Remember to comply with any applicable safety requirements when you establish and use WLAN or Bluetooth connections.

Select ringing tones

To set a ringing tone for a profile, select **Options** > **Personalise** > **Ringing tone**. Select a ringing tone from the list, or select **Download sounds** to open a bookmark folder containing a list of bookmarks for downloading tones using the browser. Any downloaded tones are saved to Gallery.

To play the ringing tone for a selected contact group only, select **Options** > **Personalise** > **Alert for**, and select the desired group. Phone calls coming from outside that group have a silent alert.

To change the message tone, select **Options** > **Personalise** > **Message alert tone**.

Change the display theme

Select **Menu** > **Ctrl. panel** > **Themes**.

Select from the following:

General — Change the theme used in all applications.

Menu view — Change the theme used in the main menu.

Standby — Change the theme used in the home screen.

Wallpaper — Change the background image of the home screen.

Call image — Change the image displayed during calls.

Audio themes — Set sounds for various device events.

To activate or deactivate the theme effects, select **General** > **Options** > **Theme effects**.

3-D ringing tones

Select **Menu** > **Applications** > **3-D tones**.

To enable three-dimensional (3-D) sound effects for ringing tones, select **3-D ringing tone effects** > **On**. Not all ringing tones support 3-D effects.

To change the 3-D effect that is applied to the ringing tone, select **Sound trajectory** and the desired effect.

To modify the 3-D effect, select from the following:

Trajectory speed — Select the speed at which sound moves from one direction to another. This setting is not available for all effects.

Reverberation — Select the desired effect to adjust the amount of echo.

Doppler effect — Select **On** to set the ringing tone sound higher when you are closer to your device, and lower when you are farther away. This setting is not available for all effects.

To listen to the ringing tone with the 3-D effect, select **Options > Play tone**.

To adjust the volume of the ringing tone, select **Menu > Ctrl. panel > Profiles and Options > Personalise > Ringing volume**.

4. Make calls

Make a call

To make a call, open the slide, enter the phone number, including the area code, and press the call key.

If you use a headset, you do not need to open the slide to make a call.

Tip: For international calls, add the + character that replaces the international access code, and enter the country code, area code (omit the leading 0, if necessary), and phone number.

To end the call or cancel the call attempt, close the slide. If you are using a headset, to end the call, press the end key.

To make a call using the saved contacts, open the contacts list. Enter the first letters of the name, scroll to the name, and press the call key.

To make a call using the log, press the call key to view up to 20 numbers that you last called or attempted to call.

Scroll to the desired number or name, and press the call key.

To adjust the volume of an active call, use the volume keys.

To switch from a voice call to a video call, select **Options > Switch to video call**. The device ends the voice call and makes a video call to the recipient.

Answer or reject a call

Answer a call

Open the slide, or connect a headset and press the call key.

Mute the ringing tone of an incoming call

Select **Silence**.

Reject a call

Press the end key. If you activate the **Call divert > Voice calls > If busy** function in phone settings, rejecting an incoming call also diverts the call.

Send a reject call text message

Select **Silence** and **Send msg.**, edit the message text, and press the call key. With the reply message you can inform

the caller that you cannot answer the call.

Activate the reject call text message feature

Select **Menu** > **Ctrl. panel** > **Settings and Phone** > **Call** > **Reject call with message** > **Yes**.

Write a standard reject call text message

Select **Menu** > **Ctrl. panel** > **Settings and Phone** > **Call** > **Message text**, and write the message.

Voice mail

Select **Menu** > **Ctrl. panel** > **Call mailbox**.

When you open the Call mailbox application (network service) for the first time, you are asked to enter the number of your voice mailbox.

To call your voice mailbox, go to the voice mailbox, open the slide, and select **Options** > **Call voice mailbox**.

To call your mailbox in the home screen, press and hold **1**, and select the mailbox to call.

To change the mailbox number, select the mailbox and **Options** > **Change number**.

Make a conference call

- 1 Make a call to the first participant.
- 2 To make a call to another participant, select **Options** > **New call**. The first call is put on hold.
- 3 When the new call is answered, to join the first participant in the conference call, select **Options** > **Conference**.

To add a new person to the call, repeat step 2, and select **Options** > **Conference** > **Add to conference**.

Your device supports conference calls between a maximum of six participants, including yourself.

To have a private conversation with one of the participants, select **Options** > **Conference** > **Private**.

Select a participant, and select **Private**. The conference call is put on hold on your device. The other participants can still continue the conference call.

After you finish the private conversation, select **Options > Conference** to return to the conference call.

To drop a participant, select **Options > Conference > Drop participant**, scroll to the participant, and select **Drop**.

- 4 To end the active conference call, press the end key.

Speed dial a phone number

Activate speed dialling

Select **Menu > Ctrl. panel > Settings and Phone > Call > Speed dialling**.

Assign a phone number to a number key (2–9)

Select **Menu > Ctrl. panel > Speed dial**. Scroll to the key to which you want to assign the phone number, and select **Options > Assign**.

1 is reserved for the voice mailbox, and **0** for starting the web browser.

Make a call

In the standby mode, open the slide, press the assigned key, and then press the call key.

Call waiting

With the call waiting network service, you can answer a call when you have another call in progress.

Activate call waiting

Select **Menu > Ctrl. panel > Settings and Phone > Call > Call waiting**.

Answer the waiting call

Press the call key. The first call is put on hold.

Swap between an active call and a call on hold

Select **Swap**.

Connect an incoming call or a call on hold with an active call, and disconnect yourself from the calls

Select **Options > Transfer**.

End an active call

Press the end key.

End both calls

Select **Options** > **End all calls**.

Call divert

Select **Menu** > **Ctrl. panel** > **Settings** and **Phone** > **Call divert**.

Divert incoming calls to your voice mailbox or to another phone number. For details, contact your service provider.

Select the type of calls to divert and from the following:

All voice calls, All data and video calls, or All fax calls — Divert all incoming voice, data, video, or fax calls. You cannot answer the calls, only divert the calls to another number.

If busy — Divert incoming calls if you have an active call.

If not answered — Divert incoming calls after your device rings for a specified length of time. Select the length of time for the device to ring before diverting the call.

If out of reach — Divert calls when the device is switched off or out of network coverage.

If not available — Divert calls if you have an active call, do not answer, or the device is switched off or out of network coverage.

To divert calls to your voice mailbox, select a call type, a diverting option, and **Options** > **Activate** > **To voice mailbox**.

To divert calls to another phone number, select a call type, a diverting option, and **Options** > **Activate** > **To other number**. Enter the number, or select **Find** to retrieve a number saved in **Contacts**.

To check the current diverting status, scroll to the diverting option, and select **Options** > **Check status**.

To stop diverting calls, scroll to the diverting option, and select **Options** > **Deactivate**.

Call barring

Select **Menu > Ctrl. panel > Settings and Phone > Call barring**. If you have defined internet call settings, select **Internet call barring**.

You can bar the calls that can be made or received with the device (network service). To modify the settings, you need the barring password from your service provider. Call barring affects all call types.

Select from the following voice call barring settings:

Outgoing calls — Prevent making voice calls with your device.

Incoming calls — Prevent incoming calls.

International calls — Prevent calling to foreign countries or regions.

Incoming calls when roaming
— Prevent incoming calls when outside your home country.

International calls except to home country — Prevent calls to foreign countries or regions, but allow calls to your home country.

To check the status of voice call barrings, select the barring option and **Options > Check status**.

To deactivate all voice call barrings, select a barring option and **Options > Deactivate all barrings**.

To change the password used for barring voice, fax, and data calls, select **Options > Edit barring password**. Enter the current code, then the new code twice. The barring password must be four digits long. For details, contact your service provider.

Voice dialling

Your device supports enhanced voice commands. Enhanced voice commands are not dependent on the speaker's voice, so you do not need to record voice tags in advance. The device creates a voice tag for the entries in the contacts, and compares the spoken voice tag to it. The voice recognition in the device adapts to the main user's voice to recognise the voice commands better.

The voice tag for a contact is the name that is saved for the contact. To listen to the synthesised voice tag, select a contact and **Options > View details > Options > Voice tag details > Options > Play voice tag.**

! **Note:** Using voice tags may be difficult in a noisy environment or during an emergency, so you should not rely solely upon voice dialling in all circumstances.

Make a call with a voice tag

When you use voice dialling, the loudspeaker is in use. Hold the device at a short distance away when you say the voice tag.

- 1 To start voice dialling, in the home screen, press and hold the right selection key. If a compatible headset with the headset key is attached, press and hold the headset key to start voice dialling.
- 2 A short tone sounds, and **Speak now** is displayed. Say clearly the name that is saved for the contact.
- 3 The device plays a synthesised voice tag for the recognised contact, and

displays the name and number. If you do not want to call that contact, select another contact from the list of matches within 2.5 seconds, or, to cancel, select **Quit**.

If several numbers are saved for a name, the device selects the default number, if defined. Otherwise, the device selects the first available number in a contact card. You can also say the name and telephone number type, such as mobile or home.

Make a video call

When you make a video call (network service), you can see a real-time video between you and the recipient of the call. The live video captured by the camera is displayed to the video call recipient.

To be able to make a video call, you must have a USIM card and be in the coverage of a 3G network. For availability, pricing and subscription to video call services, contact your network service provider.

A video call can only be made between two parties. The video call can be made to a compatible mobile device or an ISDN client. Video calls cannot be made

while another voice, video, or data call is active.

Indicators

 You are not receiving video (the recipient is not sending video or the network is not transmitting it).

 You have denied video sending from your device. To send an image instead, select **Menu > Ctrl. panel > Settings and Phone > Call > Image in video call**.

Even if you denied video sending during a video call, the call is still charged as a video call. To check costs, contact your service provider.

- 1 In the home screen, open the slide and enter the phone number.
- 2 Select **Options > Call > Video call**.

Starting a video call may take a while. If the call is not successful (for example, video calls are not supported by the network, or the receiving device is not compatible), you are asked if you want to try a

normal call or send a message instead.

The video call is active when you see two videos, and hear the sound through the loudspeaker. The call recipient may deny video sending (indicated with ) and you only hear the voice of the caller, and may see an image or a grey screen.

End a video call

Press the end key.

Answer or decline a video call

When a video call arrives,  is displayed.

- 1 Open the slide, and press the call key. **Allow video image to be sent to caller?** is displayed.
- 2 To start sending live video, select **Yes**.

If you do not activate the video call, you only hear the sound of the caller. A grey screen replaces the video image.

Replace the grey screen with a still image captured by the camera

Select Menu > Ctrl. panel > Settings and Phone > Call > Image in video call.

End a video call

Press the end key.

Internet calls

About internet calls

With the internet call network service, you can make and receive calls over the internet. Internet call services may support calls between computers, between mobile phones, and between a VoIP device and a traditional telephone. For availability and costs, contact your internet call service provider.

To make or receive an internet call, you must be in the service area of a wireless LAN (WLAN) or have a packet data connection in a 3G network, and be connected to an internet call service.

Manage internet call services

Select Menu > Ctrl. panel > Connectivity > Net settings.

To add a new internet call service, select **Download**.

Activate internet calls

Select Menu > Contacts and an internet call service.

To make or receive internet calls, contact your service provider to receive the internet call connection settings. To connect to an internet call service, your device must be in a network service area.

To activate your internet call service, select **Options > Activate service**.

To search for available wireless LAN (WLAN) connections, select **Options > Search for WLAN**.

Make an internet call

When you have activated the internet call feature, you can make an internet call from all applications where you can make a regular voice call, such as the contacts list or log. For example, in the contacts list, scroll to the desired contact, open the slide, and select **Options > Call > Internet call**.

Make an internet call in the home screen

Enter the phone number or internet address, and select **Net call**.

Make an internet call to an internet address not starting with a number

- 1 In the home screen, press any number key, and then press the backspace key to clear the display.
- 2 To change to character mode, press the function key.
- 3 Enter the internet address, and press the call key.

Video sharing

Use video sharing (network service) to send live video or a video clip from your mobile device to another compatible mobile device during a voice call.

The loudspeaker is active when you activate video sharing. If you do not want to use the loudspeaker for the voice call while you share video, you can also use a compatible headset.



Warning:

Continuous exposure to high volume may damage your hearing. Listen to music at a moderate level, and do not hold the device near your ear when the loudspeaker is in use.

Video sharing requirements

Video sharing requires a 3G connection. Your ability to use video sharing depends on the availability of the 3G network. For more information on the service, 3G network availability, and fees associated with using this service, contact your service provider.

To use video sharing, ensure the following:

- Your device is set up for person-to-person connections.
- You have an active 3G connection and are within 3G network coverage. If you move outside the 3G network during a video sharing session, the sharing stops, while your voice call continues.
- Both the sender and recipient are registered to the 3G network. If you invite someone to a sharing session

and the recipient's device is not within 3G network coverage or does not have video sharing installed or person-to-person connections set up, the recipient does not receive invitations. You receive an error message that indicates that the recipient cannot accept the invitation.

Video sharing settings

To set up video sharing, you need person-to-person and 3G connection settings.

A person-to-person connection is also known as a Session Initiation Protocol (SIP) connection. The SIP profile settings must be configured in your device before you can use video sharing. Ask your service provider for the SIP profile settings, and save them to your device. Your service provider may send you the settings or give you a list of the needed parameters.

Add a SIP address to a contact

- 1 Select **Menu** > **Contacts**.
- 2 Select a contact or create a new contact.
- 3 Select **Options** > **View details**.

- 4 Select **Options** > **Edit**.
- 5 Select **Options** > **Add detail** > **Share video**.
- 6 Enter the SIP address in the format `username@domainname` (you can use an IP address instead of a domain name).

If you do not know the SIP address for the contact, you can use the phone number of the recipient, including the country code, to share video (if supported by the network service provider).

Set up your 3G connection

Contact your service provider to establish an agreement for you to use the 3G network.



Ensure that the 3G access point connection settings for your device are configured properly. For more information about the settings, contact your service provider.

Share live video or video clips

During an active voice call, select **Options** > **Share video**.

- 1 To share live video during the call, select **Live video**.
To share a video clip, select **Video clip** and the clip you want to share. Your device checks if the video clip needs to be converted. If needed, the video clip is automatically converted.
- 2 If the recipient has several SIP addresses or phone numbers including the country code saved in the contacts list, select the desired address or number. If the SIP address or phone number of the recipient is not available, enter the address or number of the recipient including the country code, and select **OK** to send the invitation. Your device sends the invitation to the SIP address.
Sharing begins automatically when the recipient accepts the invitation.

Options during video sharing

-  Zoom the video (available for sender only).
-  Adjust the brightness (available for sender only).



Mute or unmute the microphone.



Turn the loudspeaker on and off.



Pause and resume video sharing.



Switch to full screen mode (available for receiver only).

- 3 To stop sharing video, select **Stop**. To end the voice call, press the end key. When you end the call, video sharing also ends.

To save the live video you shared, select **Yes** when prompted. The device notifies you of the memory location of the saved video. To define the preferred memory location, select **Menu > Ctrl. panel > Settings and Connection > Video sharing > Preferred saving memory**.

If you access other applications while you are sharing a video clip, the sharing is paused. To return to the video sharing view, and to continue sharing, in the home screen, select **Options > Resume video sharing**.

Call and data registers

Select **Menu** > **Log**.

To view recently missed, received, and dialled calls, select **Recent calls**.

Tip: To view the dialled numbers when in the home screen, press the call key. This functionality is not available if you are in the contacts bar. In the contacts bar, pressing the call key initiates a call to a contact.

To view the approximate duration of calls to and from your device, select **Call duration**.

To view the amount of data transferred during packet data connections, select **Packet data**.

5. Contacts

Stay connected with your online friends

You can synchronise the contact information on your device with contacts you have on Facebook. When you allow synchronisation, you are able to view your contacts' Facebook profile information, such as their picture and status updates, in the Contacts application on your device.

Synchronising your contacts and retrieving status updates are network services. Roaming and data transfer charges may apply. If the social networking service is not available or functioning correctly, you may not be able to synchronise or retrieve status updates.

Synchronise your contacts

Open the social networking service application, and follow the instructions.

This feature may not be available in certain regions.

Save and edit names and numbers

Select **Menu** > **Contacts**.

Add a new contact to the contacts list

- 1 Select **Options** > **New contact**.
- 2 Fill in the appropriate fields, and select **Done**.

Edit a contact

Select a contact and **Options** > **View details** > **Options** > **Edit**.

Manage names and numbers

Select **Menu** > **Contacts**.

Delete a contact

Go to a contact, and select **Options** > **Delete**.

Delete several contacts

- 1 To mark a contact to be deleted, go to the contact, and select **Options** > **Mark/Unmark**.
- 2 To delete the marked contacts, select **Options** > **Delete**.

Copy a contact

Go to a contact, and select **Options** > **Copy** and the desired location.

Send a contact to another device

Select the contact and **Options > View details > Options > Send business card**.

Listen to the voice tag assigned to a contact

Select the contact and **Options > View details > Options > Voice tag details > Options > Play voice tag**.

When entering contacts or editing voice commands, do not use very short or similar names for different contacts or commands.

Using voice tags may be difficult in a noisy environment or during an emergency, so you should not rely solely upon voice dialling in all circumstances.

Ringling tones, images, and call text for contacts

You can define a ringing tone for a contact or group, and an image and a call text for a contact. When the contact calls you, the device plays the selected ringing tone and shows the call text or image if the caller's phone number is sent with the call and your device recognises it.

To define a ringing tone for a contact or a contact group, select the contact or contact group, **Options > View details > Options > Ringing tone**, and a ringing tone.

To define the call text for a contact, select the contact and **Options > View details > Options > Add text for call**. Enter the call text, and select **OK**.

- 1 To add an image for a contact saved in the device memory, select the contact and **Options > View details > Options > Add image**.
- 2 Select an image from Photos.

To remove the ringing tone, select **Default tone** from the list of ringing tones.

To view, change, or remove the image from a contact, select the contact, **Options > View details > Options > Image**, and the desired option.

6. Messaging

About messaging

With Messaging (network service), you can send and receive text, multimedia, audio, and e-mail messages. You can also receive web service messages, cell broadcast messages, and special messages containing data, and send service commands.

Select Menu > Messaging.

The available messaging types may vary. For more information, contact your service provider.

Before sending or receiving messages, you may need to do the following:

- Insert a valid SIM card in the device and be located in the service area of a cellular network.
- Verify that the network supports the messaging features you want to use and that they are activated on your SIM card.
- Define the internet access point settings on the device.
- Define the e-mail account settings on the device.

- Define the text message settings on the device.
- Define the multimedia message settings on the device.

The device may recognise the SIM card provider and automatically configure some of the message settings. If not, you may need to define the settings manually; or contact your service provider to configure the settings.

The appearance of a picture message may vary depending on the receiving device.

Only devices that have compatible features can receive and display multimedia messages. The appearance of a message may vary depending on the receiving device.

Write and send messages

Select Menu > Messaging.

 **Important:** Exercise caution when opening messages. Messages may contain malicious software or otherwise be harmful to your device or PC.

Before you can create a multimedia message or write an e-mail, you must have the correct connection settings in place.

The wireless network may limit the size of MMS messages. If the inserted picture exceeds this limit, the device may make it smaller so that it can be sent by MMS.

Check the size limit of e-mail messages with your service provider. If you attempt to send an e-mail message that exceeds the size limit of the e-mail server, the message is left in the Outbox folder, and the device attempts to resend it periodically. Sending an e-mail requires a data connection, and continuous attempts to resend the e-mail may increase your data transfer costs. In the Outbox folder, you can delete such a message, or move it to the Drafts folder.

- 1 Select **New message**.
- 2 To send a text or multimedia message (MMS), select **Message**. To send a multimedia message that includes one sound clip, select **Audio message**. To send an e-mail, select **E-mail**.

- 3 In the To field, press the scroll key to select recipients or groups from the contacts list, or enter the recipient's phone number or e-mail address. You can also copy and paste the number or address from the clipboard.
- 4 In the subject field, enter the subject of the message for a multimedia or an e-mail message. To hide or display fields when writing a text or multimedia message, select **Options > Message header fields**.
- 5 In the message field, write the message. To add a template or note to a text or multimedia message, select **Options > Insert content > Insert text > Template or Note**. To add a template to an e-mail message, select **Options > Insert template**.
- 6 To add a media file to a multimedia message, select **Options > Insert content**, the file type or source, and the desired file. To add a business card, slide, note, or other file to the message, select **Options > Insert content > Insert other**.
- 7 To capture an image or record a video or sound clip for a multimedia

message, select **Options > Insert content > Insert image > New, Insert video clip > New, or Insert sound clip > New.**

- 8 To insert a smiley to a text or multimedia message, press the sym key, and select the smiley.
- 9 To add an attachment to an e-mail, select **Options > Add attachment**, the memory, and the file to attach.  indicates an e-mail attachment.
- 10 To send the message, select **Options > Send**, or press the call key.

The available options may vary.

! **Note:** The message sent icon or text on your device screen does not indicate that the message is received at the intended destination.

Your device supports text messages beyond the limit for a single message. Longer messages are sent as two or more messages. Your service provider may charge accordingly. Characters with accents, other marks, or some language options take more space, and limit the number of characters that can be sent in a single message.

You may not be able to send video clips that are saved in the MP4 file format or that exceed the size limit of the wireless network in a multimedia message.

Check the number of unread messages

Shake your device to check how many unread text and multimedia messages you have.

- 1 Make sure the keypad is locked.
- 2 Press and hold one of the volume keys, and shake the device. The number of tones indicates the number of unread messages.

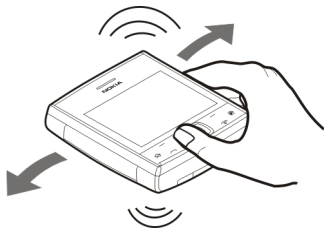

The number of tones is limited. If you have many unread messages, fewer tones may be played than there are messages.

E-mail**Set up your e-mail**

With the E-mail wizard, you can set up your corporate e-mail account, such as Mail for Exchange, and your internet e-mail account.

When setting up your corporate e-mail, you may be prompted for the name of the server associated with your e-mail address. Contact your company IT department for details before you start setting up your corporate e-mail account.

When setting up your internet e-mail, you may need to contact your e-mail service provider to obtain your e-mail account type (POP or IMAP).

- 1 To start the wizard, go to the home screen, and select the E-mail wizard.
- 2 Enter your e-mail address and password. If the wizard is not able to configure your e-mail settings automatically, you need to select your e-mail account type and enter the related account settings.

If your device contains any additional e-mail clients, those are offered to you when you start the E-mail wizard.

Send e-mail

Select Menu > Messaging.

- 1 Select your mailbox and **Options** > **Create email**.
- 2 In the To field, enter the recipient's e-mail address. If the recipient's e-mail address can be found in Contacts, start entering the recipient's name, and select the recipient from the proposed matches. If you add several recipients, insert ; to separate the e-mail addresses. Use the Cc field to send a copy to other recipients, or the Bcc field to send a blind copy to recipients. If the Bcc field is not visible, select **Options** > **More** > **Show Bcc field**.
- 3 In the Subject field, enter the subject of the e-mail.
- 4 Enter your message in the text area.
- 5 Select **Options** and from the following:

Add attachment — Add an attachment to the message.

Priority — Set the priority of the message.

Flag — Flag the message for follow-up.

Insert template — Insert text from a template.

Add recipient — Add recipients to the message from Contacts.

Editing options — Cut, copy, or paste the selected text.

Input options — Activate or deactivate predictive text input, or select the writing language.

- 6 Select **Options** > **Send**.

The available options may vary.

Read e-mail

Select **Menu** > **Messaging**.

 **Important:** Exercise caution when opening messages. Messages may contain malicious software or otherwise be harmful to your device or PC.

To read a received e-mail message, select the mailbox, and select the message from the list.

To reply to the message sender, select **Options** > **Reply**. To reply to the sender

and all other recipients, select **Options** > **Reply to all**.

To forward the message, select **Options** > **Forward**.

Download attachments

Select **Menu** > **Messaging** and a mailbox.

To view the attachments in a received e-mail message, scroll to the attachment field, and select **Options** > **Actions**. If there is one attachment in the message, select **Open** to open the attachment. If there are several attachments, select **View list** to see a list showing which attachments have been downloaded.

To download the selected attachment or all the attachments from the list to your device, select **Options** > **Actions** > **Download** or **Download all**. The attachments are not saved in your device, and are deleted when you delete the message.

To save the selected attachment or all the downloaded attachments in your

device, select **Options > Actions > Save** or **Save all**.

To open the selected, downloaded attachment, select **Options > Actions > Open**.

Disconnect from the mailbox

Select **Menu > Messaging** and a mailbox.

To cancel the synchronisation between the device and the e-mail server, and to work with e-mail without a wireless connection, select **Options > Disconnect**. If your mailbox does not have the **Disconnect** option, select **Options > Exit** to disconnect from the mailbox.

To start the synchronisation again, select **Options > Connect**.

General e-mail settings

Select **Menu > Messaging**, a mailbox, and **Options > Settings > Global settings** and from the following:

Message list layout — Select whether the e-mail messages in Inbox display one or two lines of text.

Body text preview — Select whether to preview messages when scrolling through the list of e-mail messages in Inbox.

Title dividers — Select **On** to be able to expand and collapse the list of e-mail messages.

Download notifications — Select whether to have the device to display a notification when an e-mail attachment has been downloaded.

Home screen — Define how many lines of e-mail are shown in the home screen information area.

Nokia Messaging

The Nokia Messaging service automatically pushes e-mail from your existing e-mail address to your Nokia X5-01. You can read, respond to, and organise your e-mails on the go. The Nokia Messaging service works with a number of internet e-mail providers that are often used for personal e-mail, such as Google e-mail services.

The Nokia Messaging service must be supported by your network and may not be available in all regions.

Install the Nokia Messaging application

- 1 Select **Menu > Messaging and New mailbox.**
- 2 Read the information on the display, and select **Start.**
- 3 If requested, allow your device to connect to the internet.
- 4 Select your e-mail service provider or account type.
- 5 Enter the required account details, such as e-mail address and password.

Select **Menu > Applications > Email.**

Add an additional mailbox

Select **New mailb..**

Remove a mailbox

- 1 Select **Settings.**
- 2 Scroll to a mailbox, and select **Options > Remove mailbox.**

The Nokia Messaging service can run on your device even if you have installed

other e-mail applications, such as Mail for Exchange.

About Chat

With Chat (network service), you can exchange instant messages with your friends. You can access several chat services or communities simultaneously and switch between them. If you want to, for example, browse the web, you can leave the Chat application to run in the background, and still be notified of new instant messages.

The Chat application is preinstalled on your device. To start chatting, select **Menu > Chat.**

Using network services and downloading content to your device may result in data traffic costs.

Message reader

With Message reader you can listen to text, multimedia, and audio messages and e-mail.

To listen to new messages or e-mail, in the home screen, press and hold the left selection key until Message reader starts.

To listen to a message from your Inbox or e-mail from your Mailbox, scroll to the message, and select **Options** > **Listen**. To stop the reading, press the end key.

To pause and continue the reading, press the scroll key. To skip to the next message, scroll right. To replay the current message or e-mail, scroll left. To skip to the previous message, scroll left at the beginning of the message.

To view the current message or e-mail in text format without the sound, select **Options** > **View**.

Speech

Select **Menu** > **Ctrl. panel** > **Speech**.

With the Speech application, you can set the language, voice, and voice properties for the Message reader.

Set the language for the Message reader

Select **Language**. To download additional languages to your device, select **Options** > **Download languages**.

Tip: When you download a new language, you must download at least one voice for that language.

Set the speaking voice

Select **Voice**. The voice depends on the selected language.

Set the speaking rate

Select **Speed**.

Set the speaking volume

Select **Volume**.

View details of a voice

Open the voice tab, and select the voice and **Options** > **Voice details**. To listen to a voice, select the voice and **Options** > **Play voice**.

Delete languages or voices

Select the item and **Options** > **Delete**.

Message reader settings

To change the Message reader settings, open the Settings tab, and define the following:

Language detection — Activate automatic reading language detection.

Continuous reading — Activate continuous reading of all selected messages.

Speech prompts — Set the Message reader to insert prompts in messages.

Audio source — Listen to messages through the earpiece or loudspeaker.

Messaging settings

Select Menu > Messaging and Options > Settings.

Open the message type in question, and define all fields marked with **Must be defined** or with a red asterisk.

Your device may recognise the SIM card provider and configure the correct text message, multimedia message, and GPRS settings automatically. If not, contact your service provider for the correct settings, order the settings from your service provider in a configuration message, or use the Settings wizard application.

Text message settings

Select Menu > Messaging and Options > Settings > Text message.

Select from the following:

Message centres — View the available message centres for your device, or add a new one.

Message centre in use — Select a message centre to send the message.

Character encoding — Select **Reduced support** to use automatic character conversion to another encoding system when available.

Receive report — Select **Yes** if you want the network to send you delivery reports on your messages (network service).

Message validity — Select how long the message centre resends your message if the first attempt fails (network service). If the recipient cannot be reached within the validity period, the message is deleted from the message centre.

Message sent as — Convert the message to another format, for example, fax or e-mail. Change this option only if you are sure that your message centre is able to convert text messages into these other formats. For more information, contact your service provider.

Preferred connection — Select the preferred method of connection when

sending text messages from your device.

Reply via same centre — Select whether you want the reply message to be sent using the same text message centre number (network service).

Multimedia message settings

Select **Menu > Messaging and Options > Settings > Multimedia message**.

Select from the following:

Image size — Scale images in multimedia messages.

MMS creation mode — Select **Restricted** to set your device to prevent you from including content in multimedia messages that may not be supported by the network or the receiving device. To receive warnings about including such content, select **Guided**. To create a multimedia message with no restrictions on attachment type, select **Free**. If you select **Restricted**, creating multimedia presentations is not possible.

Access point in use — Select the default access point to connect to the multimedia message centre. You may

not be able to change the default access point if it is preset in your device by your service provider.

Multimedia retrieval — Select how you want to receive messages, if available. Select **Always automatic** to receive multimedia messages always automatically, **Auto in home netw.** to receive notification of a new multimedia message that you can retrieve from the message centre (for example, when you are travelling abroad and are outside your home network), **Manual** to retrieve multimedia messages from the message centre manually, or **Off** to prevent receipt of any multimedia messages. Automatic retrieval may not be supported in all regions.

Allow anonymous msgs. — Receive messages from unknown senders.

Receive adverts — Receive messages defined as advertisements.

Receive reports — Request for delivery and read reports of sent messages (network service). Receiving a delivery report of a multimedia message that has been sent to an e-mail address may not be possible.

Deny report sending — Select **Yes** to not send delivery reports from your device for received multimedia messages.

Message validity — Select how long the messaging centre tries to send the message (network service). If the recipient of a message cannot be reached within the validity period, the message is removed from the multimedia messaging centre.

Maximum time is the maximum amount of time allowed by the network.

The device requires network support to indicate that a sent message has been received or read. Depending on the network and other circumstances, this information may not always be reliable.

Service message settings

Select **Menu > Messaging and Options > Settings > Service message**.

To allow your device to receive service messages from your service provider, select **Service messages > On**.

To select how to download services and service message content, select

Download messages > Automatically or **Manually**. If you select **Automatically**, you may still need to confirm some downloads since not all services can be downloaded automatically.

Cell broadcast settings

Select **Menu > Messaging and Options > Settings > Cell broadcast**.

To receive cell broadcast messages, select **Reception > On**.

To select the languages in which you want to receive cell broadcast messages, select **Language**.

To display new topics in the cell broadcast topics list, select **Topic detection > On**.

Other settings

Select **Menu > Messaging and Options > Settings > Other**.

Select from the following:

Save sent messages — Select whether to save sent messages in the Sent folder.

Number of saved msgs. — Enter the number of sent messages to save. When the limit is reached, the oldest message is deleted.

Memory in use — Select where to save your messages. You can save messages to the memory card only if a memory card is inserted.

Folder view — Select if you want to see folder information on one or two lines.

7. Music and audio

Music key

With the music key, the songs stored on your device are quickly at hand. You can always access Music player with a single key press.

Go to the Now playing view

Press the music key. If no song is currently playing, the last played song is displayed.

Access the Music menu

Press and hold the music key.

Music player

Play a song or podcast

Select Menu > Music > Music player.

Start playing

- 1 Select the songs or podcasts you want to play.
- 2 To play the selected items, press the scroll key.

Pause, resume, or stop playback

To pause playback, press the scroll key; to resume, press the scroll key again. To stop playback, scroll down.

Fast-forward or rewind a song

Press and hold the scroll key to the right or left.

Play songs in random order

Select Options > Shuffle play.

Repeat the current item or all items

Select Options > Repeat.

If you play podcasts, shuffle and repeat are automatically deactivated.

Modify the tone of the music playback

Select Options > Equaliser.

Modify the balance and stereo image, or enhance the bass

Select Options > Settings.

Return to the home screen, and leave the player playing in the background

Press the end key.

Close Music player

Select **Options** > **Exit**.

Spin your device to play a random song

Let your device surprise you with music! While listening to music, to play a random song from your music library, set your device on a table, and spin it.

- 1 Open Music player, and start listening to music.
- 2 To change the song, place your device on its back on an even surface, and spin it with your finger. When the device stops spinning, a random song starts playing.



Playlists

With playlists, you can create selections of songs to play in a specific order.

Select **Menu** > **Music** > **Music player** and **Playlists**.

Create a playlist

- 1 Select **Options** > **New playlist**.
- 2 Enter a name for the playlist, and select **OK**.
- 3 To add songs now, select **Yes**. To add the songs later, select **No**.
- 4 If you select **Yes**, select artists to find the songs you want to add to the playlist. To add items, select **Add**.

To display or hide the songs under an artist, select **Expand** or **Collapse**.

- 5 When you have made your selections, select **Done**.

If a compatible memory card is inserted, the playlist is saved to the memory card.

View the details of the playlist

Select **Options** > **Playlist details**.

Add more songs when viewing the playlist

Select **Options** > **Add songs**.

Add songs, albums, artists, genres, or composers to a playlist

Select an item and **Options** > **Add to playlist** > **Saved playlist** or **New playlist**.

Remove a song from a playlist

Select **Options** > **Remove**.

This does not delete the song from the device; it only removes it from the playlist.

Reorder the songs in a playlist

- 1 Select the song you want to move and **Options** > **Reorder playlist**.
- 2 Move the song into the desired position, and select **Drop**.
- 3 To move another song, select the song and **Grab**, move the song into the desired position, and select **Drop**.
- 4 To finish reordering the playlist, select **Done**.

Podcasts

Select **Menu** > **Music** > **Music player and Podcasts**.

Podcast episodes have three states: never played, partially played, and completely played. If the state is partially played, the episode plays from the last playback position the next time it is played. If the state is never played or completely played, the episode plays from the beginning.

Transfer music from a computer

You can use the following methods to transfer music:

- To install Nokia Ovi Player to manage and organise your music files, download the PC software from www.ovi.com, and follow the instructions.
- To view your device on a computer as a mass memory device where you can transfer any data files, make the connection with a compatible USB data cable or Bluetooth connectivity. If you are using a USB data cable, select **Mass storage** as the USB connection

mode. A compatible memory card must be inserted in the device.

- To synchronise music with Windows Media Player, connect a compatible USB data cable, and select **PC Suite** as the USB connection mode. A compatible memory card must be inserted in the device.

To change the default USB connection mode, select **Menu > Ctrl. panel > Connectivity > USB and USB connection mode**.

Nokia Ovi Player

With Nokia Ovi Player, you can download music from Ovi Music, transfer music to your device from your computer, and manage and organise your music files.

To download Nokia Ovi Player, go to www.ovi.com.

You need an internet connection to download music.

Download, transfer, and manage music between your computer and mobile device

- 1 Open Nokia Ovi Player on your computer. If you want to download music, register or sign in.
- 2 Use a compatible USB data cable to connect your device to the computer.
- 3 Select **PC Suite** as the USB connection mode.

Ovi Music

With Ovi Music (network service), you can search, browse, purchase, and download music to your device.

The Ovi Music service will eventually replace the Music store.

Select **Menu > Music > Ovi Music**.

To download music, you first need to register for the service.

Downloading music may involve additional costs and the transmission of large amounts of data (network service). For information about data transmission charges, contact your network service provider.

To access Ovi Music, you must have a valid internet access point in the device. You may be asked to select the access point to use when connecting to Ovi Music.

Select the access point

Select **Default access point**.

The availability and appearance of Ovi Music settings may vary. The settings may also be predefined and you may not be able to modify them. When browsing Ovi Music, you may be able to modify the settings.

Modify Ovi Music settings

Select **Options > Settings**.

Ovi Music is not available for all countries or regions.

Say and Play

With Say and Play, you can start playing the music you wish by saying, for example, the artist's name.

To start the Say and Play application, select **Menu > Music > Music search**. When the tone sounds, say an artist's

name, artist's name and song title, album title, or playlist title. Hold the device about 20 cm (8 inches) from your mouth, and speak in a regular tone. Do not cover the device microphone with your hand.

When you use Say and Play for the first time, and after you have downloaded new songs to your device, to update voice commands, select **Options > Refresh**.

The voice commands are based on the metadata (artist's name and song title) of the songs in your device. Say and Play supports two spoken languages: English and the language you have chosen as the device language. The written language of the song metadata must match either English or your chosen device language.

Tip: To improve search accuracy, use the voice commands for dialling. The dialler adapts to your voice and uses it also for music search.

Nokia Podcasting

With the Nokia Podcasting application (network service), you can search,

discover, subscribe to, and download podcasts over the air, and play, manage, and share audio and video podcasts with your device.

Podcasting settings

Select **Menu > Music > Podcasting**.

To start using Podcasting, define your connection and download settings.

Connection settings

Select **Options > Settings > Connection** and from the following:

Default access point — Select the access point to use to connect to the internet.

Search service URL — Define the podcast search service web address, to use to search for podcasts.

Download settings

Select **Options > Settings > Download** and from the following:

Save to — Define where to save podcasts.

Update interval — Define how often podcasts are updated.

Next update time — Define the time of the next automatic update.

Automatic updates only occur if a specific default access point is selected and the Podcasting application is open.

Download limit (%) — Define the percentage of memory that is reserved for podcast downloads.

If limit exceeds — Define what to do if the download limit is exceeded.

Setting the application to retrieve podcasts automatically may involve the transmission of large amounts of data through your service provider's network. For information on data transmission charges, contact your service provider.

Restore default settings

Select **Options > Restore default**.

Download podcasts

After you have subscribed to a podcast, you can download, play, and manage the podcast episodes.

Select **Menu > Music > Podcasting**.

View a list of subscribed podcasts

Select **Podcasts**.

View individual episode titles

Select the podcast title.

An episode is a particular media file of a podcast.

Start a download

Select the episode title.

You can download multiple episodes at the same time.

Start playing a podcast before the download is complete

Go to a podcast, and select **Options** > **Play preview**.

Successfully downloaded podcasts are stored in the Podcasts folder, but may not be displayed immediately.

FM Radio

Listen to the radio

Select **Menu** > **Music** > **Radio** > **FM radio**.

Search for a station

Select  or .

Go to the next or previous saved station

Select  or .

Select **Options** and from the following:

Activate loudspeaker — Listen to the radio using the loudspeaker.

Manual tuning — Change the frequency manually.

Station directory — View available stations based on location (network service).

Save station — Save the current station.

Stations — View your saved stations.

Play in background — Return to the home screen while listening to the FM radio in the background.

The quality of the radio broadcast depends on the coverage of the radio station in that particular area.

You can make a call or answer an incoming call while listening to the radio. The radio is muted during an active call.

 **Warning:**

Continuous exposure to high volume may damage your hearing. Listen to music at a moderate level, and do not hold the device near your ear when the loudspeaker is in use.

Internet radio**About Internet radio**

Select **Menu > Music > Radio > Internet radio**.

With the Internet radio (network service), you can listen to radio stations that broadcast on the internet.

You must have a wireless local area network (WLAN) or packet data access point (GPRS or 3G) defined in your device. The recommended connection method is WLAN.

Using a packet data connection to listen to an internet radio station may involve the transmission of large amounts of data through your service provider's network. For information about data transmission charges, contact your service provider.

Listen to internet radio stations

Select **Menu > Music > Radio > Internet radio**.

To listen to a radio station on the internet, do the following:

- 1 Select a station from your favourites or the station directory, or search for stations by name from the Nokia Internet Radio service.

To add a station manually, select **Options > Add station manually**. You can also browse for station links with the Web browser application. Compatible links are automatically opened in the Internet Radio application.

- 2 Select **Options > Listen**.

The Now playing view opens, displaying information about the currently playing station and song.

To pause the playback, press the scroll key; to resume, press the scroll key again.

To view station information, select **Options > Station information** (not

available if you have saved the station manually).

If you are listening to a station saved in your favourites, scroll left or right to listen to the previous or next saved station.

Recorded sound clips are saved in the Sound clips folder in Gallery.

To record a telephone conversation, open recorder during a voice call, and select . Both parties hear a tone at regular intervals during recording.

Recorder

Select **Menu > Music > Recorder**.

With the Recorder application, you can record voice memos and telephone conversations.

The recorder cannot be used when a data call or GPRS connection is active.

To record a sound clip, select .

To stop recording a sound clip, select .

To listen to the sound clip, select .

To select the recording quality or where you want to save your sound clips, select **Options > Settings**.

8. Images and videos

Camera

Capture an image

Select **Menu > Applications > Camera**.

When capturing an image, note the following:

- Use both hands to keep the camera steady.
 - The quality of a digitally zoomed image is lower than that of a non-zoomed image.
 - The camera goes into battery saving mode after about a minute of inactivity.
 - Keep a safe distance when using the flash. Do not use the flash on people or animals at close range. Do not cover the flash while taking a picture.
- 1 To switch from video mode to image mode, if necessary, select .
 - 2 Press the scroll key. Do not move the device before the image is saved and the final image displayed.

Zoom in or out when capturing an image

Use the zoom keys.

Images are automatically saved in Gallery.

Flash and video light

The camera of your device has an LED flash for low light conditions.

From the active toolbar, select one of the following flash modes:  **Automatic**,

 **Reduce red**,  **On**, and  **Off**.

Avoid touching the flash LEDs. The LEDs may get hot after prolonged usage.

Keep a safe distance when using the flash. Do not use the flash on people or animals at close range. Do not cover the flash while taking a picture.

Increase light levels when recording video in low light

Select .

Record videos

Select **Menu** > **Applications** > **Camera**.

- 1 If the camera is in image mode, select video mode from the toolbar.
- 2 To start recording, press the scroll key.
- 3 To pause recording, select **Pause**. Select **Continue** to resume recording.
- 4 To stop recording, select **Stop**. The video clip is automatically saved in Gallery. The maximum length of the video clip depends on the available memory.

Gallery

About Gallery

Select **Menu** > **Gallery**.

Gallery is a storage place for your images, video and sound clips, songs, and streaming links.

Main view

Select **Menu** > **Gallery**.

Select from the following:

Images  — View images and video clips in Photos.

Video clips  — View video clips in Video centre.

Songs  — Open Music player.

Sound clips  — Listen to sound clips.

Streaming links  — View and open streaming links.

Presentations  — View presentations.

You can browse and open folders and copy and move items to folders. You can also create albums and copy and add items to albums.

Files stored on your compatible memory card (if inserted) are indicated with



To open a file, select the file from the list. Video clips and streaming links open and play in Video centre, and music and sound clips in Music player.

To copy or move files to another memory location, select a file, **Options** > **Move and copy**, and the appropriate option.

Photos

About Photos

Select **Menu** > **Gallery** > **Images** and from the following:

Captured — View all the images and videos you have captured.

Months — View images and videos categorised by the month they were captured.

Albums — View the default albums and the ones you have created.

Tags — View the tags you have created for each item.

Downloads — View items and videos downloaded from the web or received as a multimedia or e-mail message.

All — View all items.

Share online — Post your images or videos to the web.

Files stored on your compatible memory card (if inserted) are indicated with



To copy or move files to another memory location, select a file, **Options** > **Move and copy**, and from the available options.

Organise images and videos

Select **Menu** > **Gallery** > **Images**. You can organise files as follows:

To view items in the Tags view, add tags to the items.

To view items by months, select **Months**.

To create an album to store items, select **Albums** > **Options** > **New album**.

To add an image or a video clip to an album, select the item and **Options** > **Add to album**.

To delete an image or video clip, select the item and **Delete** from the active toolbar.

Share online

About Share online

Select **Menu** > **Internet** > **Share online**.

With Share online (network service), you can post your images, video clips, and sound clips from your device to compatible online sharing services, such as albums and blogs. You can also

view and send comments to the posts in these services, and download content to your compatible Nokia device.

The supported content types and the availability of the Share online service may vary.

Subscribe to services

Select **Menu** > **Internet** > **Share online**.

To subscribe to an online sharing service, go to the service provider's website, and check that your Nokia device is compatible with the service. Create an account as instructed on the website. You receive a user name and password needed to set up your device with the account.

- 1 To activate a service, open the Share online application in your device, select a service and **Options** > **Activate**.
- 2 Allow the device to create a network connection. If you are prompted for an internet access point, select one from the list.
- 3 Sign in to your account as instructed on the service provider's website.

For the availability and cost of the third party services and data transfer costs, contact your service provider or the relevant third party.

Create a post

Select **Menu** > **Internet** > **Share online**.

To post media files to a service, go to a service, and select **Options** > **New upload**. If the online sharing service provides channels for posting files, select the desired channel.

To add an image, video clip, or sound clip to the post, select **Options** > **Insert**.

Enter a title or description for the post, if available.

To add tags to the post, select **Tags**.

To send the post to the service, select **Options** > **Upload**.

Post files from Photos

You can post your files from Photos to an online sharing service.

- 1 Select **Menu > Gallery > Images** and the files you want to post.
- 2 Select **Options > Send > Upload** and the desired account.
- 3 Edit your post as required.
- 4 Select **Options > Upload**.

Video Centre

With Video Centre (network service), you can download and stream video clips over the air from compatible internet video services using packet data or WLAN. You can also transfer video clips from a compatible PC to your device and view them in Video centre.

Using packet data access points to download videos may involve the transmission of large amounts of data through your service provider's network. Contact your service provider for information about data transmission charges.

Select **Menu > Gallery > Video clips**.

Your device may have predefined services. Service providers may provide free content or charge a fee. Check the pricing in the service or from the service provider.

RealPlayer

Select **Menu > Applications > RealPlayer**.

RealPlayer plays video and sound clips that are stored on your device, transferred from an e-mail message, or a compatible computer, or streamed to your device over the web. Supported file formats include MPEG-4, MP4 (not streaming), 3GP, RV, RA, AMR, and Midi. RealPlayer does not necessarily support all variations of a media file format.

Play video clips and stream links

To play a video clip, select **Video clips** and a clip.

To list recently played files, in the application main view, select **Recently played**.

To stream content over the air (network service), select **Streaming links** and a link. RealPlayer recognises two kinds of links: an rtsp:// URL and an http:// URL that points to a RAM file. Before the content begins streaming, your device must connect to a website and buffer the content. If a network connection problem causes a playback error,

RealPlayer attempts automatically to reconnect to the internet access point.

To download video clips from the web, select **Downld. videos**.

To adjust the volume during playback, use the volume keys.

To fast-forward during playback, scroll right and hold. To rewind during play, scroll left and hold.

To stop the playback or streaming, select **Stop**. Buffering or the connection to the streaming site stops, the playback of the clip stops, and the clip rewinds to the beginning.

To view the video clip in normal screen mode, select **Options > Continue in normal scr..**

View information about a media clip

To view the properties of a video or sound clip, or web link, select **Options > Clip details**. Information may include for example the bit rate or the internet link of a streaming file.

RealPlayer settings

Select **Menu > Applications > RealPlayer**.

You may receive RealPlayer settings in a message from your service provider.

To define the settings manually, select **Options > Settings > Video or Streaming**.

9. Internet

About Browser

 With the Browser application, you can view web pages on the internet.

Select **Menu > Internet > Web**.

If the web page displays unreadable characters while browsing, select **Menu > Internet > Web and Options > Settings > Page > Default encoding**, and a corresponding encoding.

To browse the web, you need to have an internet access point configured in your device. The browser requires network service.

Browse the web

With the Browser application, you can browse web pages.

Select **Menu > Internet > Web**.

Shortcut: To open Browser, press and hold **0** in the home screen.

Go to a web page

In the bookmarks view, select a bookmark, or start entering a web

address (the  field opens automatically), and select **Go to**.

Some web pages may contain material, such as video clips, that requires a large amount of memory to view. If your device runs out of memory while loading such a web page, insert a memory card. Otherwise, the video clips are not displayed.

Disable graphics to save memory and speed up downloading

Select **Options > Settings > Page > Load content > Text only**.

Refresh the content of the web page

Select **Options > Web page options > Reload**.

View snapshots of web pages you have visited

Select **Back**. A list of pages you have visited during the current browsing session opens. This option is available if **History list** is activated in the browser settings.

Block or allow the automatic opening of multiple windows

Select **Options** > **Web page options** > **Block pop-ups** or **Allow pop-ups**.

View the shortcut keys

Select **Options** > **Keypad shortcuts**. To edit the shortcut keys, select **Edit**.

Zoom in or out on a web page

Press * or #.

Tip: To go to the home screen without exiting the Browser application or closing the connection, press the end key once.

Browser toolbar

The browser toolbar helps you select frequently used functions of the browser.

Open the toolbar

Press and hold the scroll key on a blank area of a web page.

Move within the toolbar

Scroll left or right.

Select a feature from the toolbar

Press the scroll key

From the toolbar, select from the following:

 **Go to web address** — Enter a web address.

 **Recently visited pages** — View a list of the web addresses you visit frequently.

 **Bookmarks** — Open the bookmarks view.

 **Full screen** — View the web page in full screen.

 **Page overview** — Display an overview of the current web page.

 **Search by keyword** — Search the current web page.

 **Settings** — Modify the web browser settings.

Navigate pages

When you are browsing a large web page, you can use Mini Map or Page overview to view the page at one glance.

Select **Menu** > **Internet** > **Web**.

Activate the Mini Map

Select **Options** > **Settings** > **General** > **Mini map** > **On**.

When you scroll through a large web page, the Mini Map opens and shows an overview of the page.

Move on the Mini Map

Scroll left, right, up, or down. When you find the desired location, stop scrolling. The Mini Map disappears and leaves you at the selected location.

Find information on a web page with Page overview

- 1 Press **8**. A miniature image of the current web page opens.
- 2 Move on the miniature image by scrolling up, down, left, or right.
- 3 When you find a section you want to view, select **OK** to go to that section on the web page.

Web feeds and blogs

With web feeds, you can easily follow news headlines and your favourite blogs.

Select **Menu** > **Internet** > **Web**.

Web feeds are XML files on web pages. They are used to share, for example, the latest news headlines or blogs. It is common to find web feeds on web, blog, and wiki pages.

The browser application automatically detects if a web page contains web feeds.

Subscribe to a web feed when a feed is available on the page

Select **Options** > **Subscribe to web feeds**.

Update a web feed

In the Web feeds view, select a feed and **Options** > **Web feed options** > **Refresh**.

Set automatic update for all web feeds

In the Web feeds view, select **Options** > **Edit** > **Edit**. This option is not available if one or more feeds are marked.

Bookmarks

You can store your favourite web pages in Bookmarks for instant access.

Select **Menu** > **Internet** > **Web**.

Access bookmarks

- 1 If you have a page other than Bookmarks as your homepage, select **Options > Go to > Bookmarks**.
- 2 Select a web address from the list or from the collection of bookmarks in the Recently visited pages folder.

Save the current web page as a bookmark

While browsing, select **Options > Web page options > Save as bookmark**.

Edit or delete bookmarks

Select **Options > Bookmark manager**.

Send or add a bookmark, or set a bookmarked web page as the homepage

Select **Options > Bookmark options**.

Empty the cache

Emptying the cache memory helps you keep your data secure. The information or services you have accessed are stored in the cache memory of the device. If you have accessed or tried to access confidential information requiring

passwords, empty the cache after each browsing session.

Select **Options > Clear privacy data > Cache**.

End the connection

End the connection and close the Browser application

Select **Options > Exit**.

Delete cookies

Select **Options > Clear privacy data > Cookies**. Cookies contain information collected about your visits to web pages.

Connection security

If the security indicator () is displayed during a connection, the data transmission between the device and the internet gateway or server is encrypted.

The security icon does not indicate that the data transmission between the gateway and the content server (where the data is stored) is secure. The service provider secures the data transmission

between the gateway and the content server.

certificate really belongs to the listed owner.

Security certificates may be required for some services, such as banking services. You are notified if the identity of the server is not authentic or if you do not have the correct security certificate in your device. For more information, contact your service provider.

 **Important:** Even if the use of certificates makes the risks involved in remote connections and software installation considerably smaller, they must be used correctly in order to benefit from increased security. The existence of a certificate does not offer any protection by itself; the certificate manager must contain correct, authentic, or trusted certificates for increased security to be available. Certificates have a restricted lifetime. If "Expired certificate" or "Certificate not valid yet" is shown, even if the certificate should be valid, check that the current date and time in your device are correct.

Before changing any certificate settings, you must make sure that you really trust the owner of the certificate and that the

10. Time management

Calendar

About Calendar

Select **Menu > Calendar**.

With calendar, you can create and view scheduled events and appointments, and switch between different calendar views.

In the month view, calendar entries are marked with a triangle. Anniversary entries are also marked with an exclamation mark. The entries of the selected day are displayed as a list.

To open calendar entries, select a calendar view and an entry.

Whenever you see the  icon, scroll right to access a list of available actions. To close the list, scroll left.

Create calendar entries

Select **Menu > Calendar**.

You can create the following types of calendar entries:

- Meeting entries remind you of events that have a specific date and time.
- Meeting requests are invitations that you can send to the participants. Before you can create meeting requests you must have a compatible mailbox configured to your device.
- Memo entries are related to the whole day but not to a specific time of the day.
- Anniversary entries remind you of birthdays and special dates. They refer to a certain day but not a specific time of the day. Anniversary entries are repeated every year.
- To-do entries remind you of a task that has a due date but not a specific time of the day.

To create a calendar entry, select a date, **Options > New entry**, and the entry type.

To set the priority for meeting entries, select **Options > Priority**.

To define how the entry is handled during synchronisation, select **Private** to hide the entry from viewers if the

calendar is available online, **Public** to make the entry visible to viewers, or **None** to not copy the entry to your computer.

To send the entry to a compatible device, select **Options > Send**.

To make a meeting request of a meeting entry, select **Options > Add participants**.

Create meeting requests

Select **Menu > Calendar**.

Before you can create meeting requests, you must have a compatible mailbox configured for your device.

To create a meeting entry:

- 1 To create a meeting entry, select a day and **Options > New entry > Meeting request**.
- 2 Enter the names of the required participants. To add names from your contacts list, enter the first few characters, and select from the proposed matches. To add optional participants, select **Options > Add optional participants**.

- 3 Enter the subject.
- 4 Enter the start and end times and dates, or select **All-day event**.
- 5 Enter the location.
- 6 Set an alarm for the entry, if needed.
- 7 For a recurring meeting, set the recurrence time, and enter the end date.
- 8 Enter a description.

To set the priority for the meeting request, select **Options > Priority**.

To send the meeting request, select **Options > Send**.

Calendar views

Select **Menu > Calendar**.

You can switch between the following views:

- Month view shows the current month and the calendar entries of the selected day in a list.
- Week view shows the events for the selected week in seven day boxes.

- Day view shows the events for the selected day grouped into time slots according to their starting time.
- To-do view shows all to-do items.
- Agenda view shows the events for the selected day in a list.

To change the view, select **Options** > **Change view** and the desired view.

Tip: To open the week view, select the week number.

To move to the next or the previous day in month, week, day, and agenda view, select the desired day.

To change the default view, select **Options** > **Settings** > **Default view**.

Set time and date

Select **Menu** > **Applications** > **Clock**.

Select **Options** > **Settings** and from the following:

Time — Set the time.

Date — Set the date.

Automatic time update — Set the network to automatically update the

time, date, and time zone information for your device (network service).

Alarm clock

Select **Menu** > **Applications** > **Clock**.

To view your active and inactive alarms, open the alarms tab. To set a new alarm, select **Options** > **New alarm**. Define the repetition, if needed. When an alarm is active,  is displayed.

To turn off the sounding alarm, select **Stop**. To stop the alarm for a certain time period, select **Snooze**.

If your device is switched off when an alarm is due, your device switches itself on and starts sounding the alarm tone.

Tip: To define the time period after which the alarm sounds again when you set it to snooze, select **Options** > **Settings** > **Alarm snooze time**.

To cancel an alarm, select **Options** > **Remove alarm**.

To change the time, date, and clock type settings, select **Options** > **Settings**.

To automatically update the time, date, and time zone information to your device (network service), select **Options > Settings > Automatic time update > On.**

11. Office applications

Active notes

Select **Menu > Applications > Active notes**.

Active notes allows you to create, edit, and view different kinds of notes, for example, meeting memos, hobby notes, or shopping lists. You can insert images, videos, and sound in the notes. You can link notes to other applications, such as Contacts, and send notes to others.

Create and edit notes

Select **Menu > Applications > Active notes**.

Create a note

Start writing.

Edit a note

Select **Options > Editing options**.

Add boldface, italics, or underlining

Press and hold the shift key, and scroll to select the text. Then select **Options > Text**.

Select **Options** and from the following:

Insert object — Insert items to the note.

Send — Send the note to a compatible device.

Link note to call — Select **Add contacts** to link a note to a contact. The note is displayed when making a call to or receiving a call from the contact.

Active notes settings

Select **Menu > Applications > Active notes and Options > Settings**.

Select where to save notes

Select **Memory in use** and the desired memory.

Change the layout of active notes

Select **Change view > Grid or List**.

Display a note during phone calls

Select **Show note during call > Yes**.

Tip: If you temporarily do not want to see notes during phone calls, select **Show note during call > No**. This way you do not have to remove the links between notes and contact cards.

Calculator

Select **Menu > Applications > Calculator**.

This calculator has limited accuracy and is designed for simple calculations.

To make a calculation, enter the first number of the calculation. Select a function such as add or subtract from the function map. Enter the second number of the calculation, and select **=**. The calculator performs operations in the order they are entered. The result of the calculation remains in the editor field and can be used as the first number of a new calculation.

The device saves the result of the last calculation in its memory. Exiting the Calculator application or switching off the device does not clear the memory. To recall the last saved result the next time you open the Calculator application, select **Options > Last result**.

To save the numbers or results of a calculation, select **Options > Memory > Save**.

To retrieve the results of a calculation from the memory and use them in a calculation, select **Options > Memory > Recall**.

Converter

Select **Menu > Applications > Converter**.

The converter has limited accuracy, and rounding errors may occur.

Convert measurements

Select **Menu > Applications > Converter**.

- 1 Scroll to the type field, and select **Options > Conversion type** to open a list of measures. Select the measurement type to use (other than currency) and **OK**.
- 2 Scroll to the first unit field, and select **Options > Select unit**. Select the unit from which to convert and **OK**. Scroll to the next unit field, and select the unit to which to convert.
- 3 Scroll to the first amount field, and enter the value to convert. The other amount field changes

automatically to show the converted value.

Set base currency and exchange rate

Select **Menu > Applications > Converter**.

When you change base currency, you must enter new exchange rates because all previously set exchange rates are cleared.

Before you can make currency conversions, you must choose a base currency and add exchange rates. The rate of the base currency is always 1. The base currency determines the conversion rates of the other currencies.

- 1 To set the exchange rate for the unit of currency, scroll to the type field, and select **Options > Currency rates**.
- 2 Scroll to the currency type, and enter the exchange rate you would like to set per single unit of currency.
- 3 To change the base currency, scroll to the currency, and select **Options > Set as base currency**.

- 4 Select **Done > Yes** to save the changes.

After you have set all the necessary exchange rates, you can make currency conversions.

Zip manager



Select **Menu > Applications > Zip**.

With Zip manager, you can create new archive files to store compressed ZIP formatted files; add single or multiple compressed files or directories to an archive; set, clear, or change the archive password for protected archives; and change settings, such as the level of compression used.

You can save the archived files in the device memory or on a memory card.

Dictionary

You can translate words from one language to another. Not all languages may be supported.

Look up a word to translate

- 1 Select **Menu > Applications > Dictionary**.

- 2 Enter text in the search field. As you enter text, suggestions of words to translate are displayed.
- 3 Select the word from the list.

Select **Options** and from the following:

Listen — Listen to the selected word.

History — Find previously translated words from the current session.

Languages — Change the source or target language, download languages from the internet, or remove a language from the dictionary. You cannot remove the English language from the dictionary. You can have two additional languages installed, besides English.

Speech — Edit the voice feature settings. You can adjust the speed and volume of the voice.

Notes

Select **Menu > Applications > Notes**.

You can create and send notes to other compatible devices, and save received plain text files (TXT file format) to Notes.

To write a note, start entering the text. The note editor opens automatically.

To open a note, select **Open**.

To send a note to other compatible devices, select **Options > Send**.

To synchronise or to define synchronisation settings for a note, select **Options > Synchronisation**. Select **Start** to initialise synchronisation or **Settings** to define the synchronisation settings for the note.

12. Connectivity

Data connections and access points

Your device supports packet data connections (network service), such as GPRS in the GSM network. When you use your device in GSM and 3G networks, multiple data connections can be active at the same time, and access points can share a data connection. In the 3G network, data connections remain active during voice calls.

You can also use a WLAN data connection. Only one connection in one wireless LAN can be active at a time, but several applications can use the same internet access point.



To establish a data connection, an access point is required. You can define different kinds of access points, such as the following:

- MMS access point to send and receive multimedia messages
- Internet access point (IAP) to send and receive e-mail and connect to the internet

Check the type of access point you need with your service provider for the

service you want to access. For availability and subscription to packet data connection services, contact your service provider.

Network settings

Your device can automatically switch between GSM and 3G networks. The GSM network is indicated with  in the standby mode. The 3G network is indicated with .

Select **Menu > Ctrl. panel > Settings and Phone > Network** and from the following:

Network mode — Select which network to use. If you select **Dual mode**, the device uses the GSM or 3G network automatically, according to the network parameters and the roaming agreements between the wireless service providers. For details and roaming costs, contact your network service provider. This option is shown only if supported by the wireless service provider.

A roaming agreement is an agreement between two or more service providers to enable the users of one service

provider to use the services of other service providers.

Operator selection — Select **Automatic** to set the device to search for and select one of the available networks, or **Manual** to manually select the network from a list. If the connection to the manually selected network is lost, the device sounds an error tone and asks you to reselect a network. The selected network must have a roaming agreement with your home cellular network.

Cell info display — Set the device to indicate when it is used in a cellular network based on microcellular network (MCN) technology and to activate cell info reception.

Wireless LAN

About WLAN

Your device can detect and connect to wireless local area networks (WLAN). Using a WLAN, you can connect your device to the internet and compatible devices that support WLAN.

To use a WLAN connection, you need the following:

- WLAN must be available in your location.
- Your device must be connected to the WLAN. Some WLANs are protected, and you need an access key from the service provider to connect to them.
- An internet access point created for WLAN. Use the access point for applications that need to connect to the internet.

A WLAN connection is established when you create a data connection using a WLAN internet access point. The active WLAN connection ends when you end the data connection.

You can use WLAN during a voice call or when packet data is active. You can only be connected to one WLAN access point device at a time, but several applications can use the same access point.

Features that use WLAN, or that are allowed to run in the background while using other features, increase the demand on battery power and reduce the battery life.

Your device supports the following WLAN features:

- IEEE 802.11b/g standard
- Operation at 2.4 GHz
- Wired equivalent privacy (WEP), Wi-Fi protected access (WPA/WPA2), and 802.1x authentication methods. These functions can be used only if they are supported by the network.

! **Important:** Always enable one of the available encryption methods to increase the security of your wireless LAN connection. Using encryption reduces the risk of unauthorised access to your data.

When the device is in the offline profile, you can still use WLAN, if available. Remember to comply with any applicable safety requirements when establishing and using a WLAN connection.

Tip: To check the unique media access control (MAC) address that identifies your device, enter ***#62209526#** in the home screen.

! **Note:** Using WLAN may be restricted in some countries. For example, in France, you are only allowed to use WLAN indoors. For more information, contact your local authorities.

See WLAN availability

To set your device to show wireless LAN (WLAN) availability, select **Menu > Ctrl. panel > Settings and Connection > Wireless LAN > Show WLAN availability**.

If a WLAN is available,  is displayed.

WLAN wizard

Select **Menu > Ctrl. panel > Connectivity > WLAN wiz..**

The WLAN wizard helps you find and connect to a wireless LAN (WLAN). When you open the application, your device starts to scan for available WLANs and lists them.

Select **Options** and from the following:

Refresh — Update the list of available WLANs.

Filter WLAN networks — Filter out WLANs in the list of found networks. The selected networks are filtered out the next time the application searches for WLANs.

Start web browsing — Start browsing the web using the access point of the WLAN.

Cont.web browsing — Continue web browsing using the currently active WLAN connection.

Disconnect WLAN — Disconnect the active connection to the WLAN.

Details — View the details of the WLAN.

! **Important:** Always enable one of the available encryption methods to increase the security of your wireless LAN connection. Using encryption reduces the risk of unauthorised access to your data.

In the home screen, the WLAN wizard shows the status of your WLAN connections and network searches. If the WLAN wizard is not activated by default in the home screen, you can activate it in the home screen settings.

Use the WLAN wizard in the home screen

To view the available options, select the row showing the status. Depending on the status, you can open the web browser using a WLAN connection, connect to your net call service, disconnect from a WLAN, search for WLANs, or enable or disable network scanning.

If WLAN scanning is disabled, and you are not connected to any WLAN, **WLAN scanning off** is displayed in the home screen.

To enable WLAN scanning, and to search for available WLANs, select the row showing the status.

To start a search for available WLANs, select the row showing the status and **Search for WLAN**.

To disable WLAN scanning, select the row showing the status and **Switch WLAN scan off**.

When **Start web browsing** is selected, the WLAN wizard automatically creates an access point for the selected WLAN. The access point can also be used with other applications requiring WLAN connection.

If you select a secured WLAN, you are asked to enter the relevant passcodes. To connect to a hidden network, you must enter the correct service set identifier (SSID).

To use the found WLAN for a net call connection, select the row showing the status, **Use for**, the desired net call service, and the WLAN to be used.

Active data connections

Select **Menu > Ctrl. panel > Connectivity > Conn. mgr..**

Select **Active data connections**.

In the active data connections view, you can see the open data connections:



data calls



packet data connections



wireless LAN (WLAN)
connections

Note: The actual invoice for calls and services from your service provider may vary, depending on network features, rounding off for billing, taxes, and so forth.

To end a connection, select **Options > Disconnect**.

To close all open connections, select **Options > Disconnect all**.

To view the details of a connection, select **Options > Details**.

Synchronisation

With the Sync application, you can synchronise your notes, messages, contacts, and other information with a remote server.

Select **Menu > Ctrl. panel > Connectivity > Sync**.

You may receive synchronisation settings as a configuration message from your service provider.

A synchronisation profile contains the necessary settings for synchronisation. When you open the application, the

default or previously used synchronisation profile is displayed.

Include or exclude content types

Select a content type.

Synchronise data

Select **Options** > **Synchronise**.

Create a new synchronisation profile

Select **Options** > **New sync profile**.

Manage synchronisation profiles

Select **Options** and the desired option.

Bluetooth

Select **Menu** > **Ctrl. panel** > **Connectivity** > **Bluetooth**.

About Bluetooth

Bluetooth technology in your device enables wireless connections between electronic devices within a range of 10 metres (33 feet). A Bluetooth connection can be used to send images, videos, text, business cards, calendar notes, or to connect wirelessly to devices that use Bluetooth technology.

Since devices using Bluetooth technology communicate using radio

waves, your device and the other devices do not need to be in direct line-of-sight. The two devices only need to be within a maximum of 10 metres of each other, although the connection can be subject to interference from obstructions such as walls or other electronic devices.

Several Bluetooth connections can be active at a time. For example, if your device is connected to a headset, you can also transfer files to another compatible device at the same time.

This device is compliant with Bluetooth Specification 2.0 + EDR supporting the following profiles: Advanced Audio Distribution, Audio/Video Remote Control, Basic Imaging, Device Identification, Dial-Up Networking, File Transfer, Generic Access, Generic Audio/Video Distribution, Generic Object Exchange, Hands-free, Headset, Object Push, Phonebook Access, Serial Port, and Remote SIM Access. To ensure interoperability between other devices supporting Bluetooth technology, use Nokia approved accessories for this model. Check with the manufacturers of other devices to determine their compatibility with this device.

Features using Bluetooth technology increase the demand on battery power and reduce the battery life.

Send and receive data with Bluetooth

Select **Menu > Ctrl. panel > Connectivity > Bluetooth.**

- 1 When you activate Bluetooth connectivity for the first time, you are asked to name your device. Give your device a unique name to make it easy to recognise if there are several Bluetooth devices nearby.
- 2 Select **Bluetooth > On.**
- 3 Select **My phone's visibility > Shown to all** or **Define period.** If you select **Define period**, you need to define the time during which your device is visible to others. Your device and the name you entered can now be seen by other users with devices using Bluetooth technology.
- 4 Open the application where the item you want to send is stored.
- 5 Select the item and **Options > Send > Via Bluetooth.** The device searches for other devices using

Bluetooth technology within range and lists them.

Tip: If you have sent data using Bluetooth connectivity before, a list of the previous search results is displayed. To search for more Bluetooth devices, select **More devices.**

- 6 Select the device with which you want to connect. If the other device requires pairing before data can be transmitted, you are asked to enter a passcode.

When the connection has been established, **Sending data** is displayed.

The Sent folder in the Messaging application does not store messages sent using Bluetooth connectivity.

To receive data using Bluetooth connectivity, select **Bluetooth > On** and **My phone's visibility > Shown to all** to receive data from a non-paired device or **Hidden** to receive data from a paired device only. When you receive data through Bluetooth connectivity, depending on the settings of an active profile, a tone sounds, and you are asked if you want to accept the message

in which the data is included. If you accept, the message is placed in the Inbox folder in the Messaging application.

Tip: You can access the files in the device or on the memory card using a compatible accessory that supports the File Transfer Profile Client service (for example, a laptop computer).

A Bluetooth connection is disconnected automatically after sending or receiving data. Only Nokia Ovi Suite and some accessories such as headsets may maintain a connection even if not actively used.

Pair devices

Select **Menu > Ctrl. panel > Connectivity > Bluetooth.**

Open the paired devices tab.

Before pairing, decide on your own passcode (1-16 digits), and agree with the user of the other device to use the same code. Devices that do not have a user interface have a fixed passcode. You need the passcode only when you connect the devices for the first time.

After pairing, it is possible to authorise the connection. Pairing and authorising the connection makes connecting quicker and easier, as you do not have to accept the connection between paired devices every time you establish a connection.

The passcode for remote SIM access must have 16 digits.

In remote SIM mode you can use your device's SIM card with compatible accessories.

When the wireless device is in the remote SIM mode, you can only use a compatible connected accessory, such as a car kit, to make or receive calls.

Your wireless device will not make any calls, except to the emergency numbers programmed into your device, while in this mode.

To make calls, you must first leave the remote SIM mode. If the device has been locked, enter the lock code to unlock it first.

- 1 Select **Options > New paired device.** The device starts to search for Bluetooth devices within range.

If you have sent data using Bluetooth connectivity before, a list of the previous search results is displayed. To search for more Bluetooth devices, select **More devices**.

- 2 Select the device with which you want to pair, and enter the passcode. The same passcode must be entered in the other device as well.
- 3 To make the connection between your device and the other device automatic, select **Yes**. To confirm the connection manually every time a connection attempt is made, select **No**. After pairing, the device is saved to the paired devices page.

To give a nickname to the paired device, select **Options > Assign short name**. The nickname is displayed in your device.

To delete a pairing, select the device whose pairing you want to delete and **Options > Delete**. To delete all pairings, select **Options > Delete all**. If you are currently connected to a device and cancel the pairing with that device,

pairing is removed immediately, and the connection is ended.

To allow a paired device to connect automatically to your device, select **Set as authorised**. Connections between your device and the other device can be made without your knowledge. No separate acceptance or authorisation is needed. Use this status only for your own devices, such as your compatible headset or computer, or devices that belong to someone you trust. If you want to accept connection requests from the other device separately every time, select **Set as unauthorised**.

To use a Bluetooth audio accessory, such as a Bluetooth handsfree or headset, you need to pair your device with the accessory. For the passcode and further instructions, see the accessory user guide. To connect to the audio accessory, switch on the accessory. Some audio accessories connect automatically to your device. Otherwise, open the paired devices tab, and select the accessory and **Options > Connect to audio device**.

Data cable

To avoid corrupting data, do not disconnect the USB data cable during data transfer.

Copy a picture or other content between your device and a computer

- 1 Insert a memory card in your device, and connect the device to a compatible PC or Mac computer with the data cable.
- 2 When the device asks which mode to use, select **Mass storage**. In this mode, you can see your device as a removable hard drive in your computer.
- 3 End the connection from the computer (from the Unplug or Eject Hardware wizard in Microsoft Windows, for example) to avoid damaging the memory card.

To use Nokia Ovi Suite with your device, install Nokia Ovi Suite on your PC, connect the data cable, and select **PC Suite** as the USB connection mode.

To synchronise the music in your device with Nokia Ovi Player, install the Nokia Ovi Player software on your PC, connect

the data cable, and select **PC Suite** as the USB connection mode.

To change the USB mode you normally use with the data cable, select **Menu > Ctrl. panel > Connectivity > USB and USB connection mode**, and the desired option.

To set the device to ask for the mode each time you connect the data cable to the device, select **Menu > Ctrl. panel > Connectivity > USB and Ask on connection > Yes**.

PC connections

You can use your mobile device with a variety of compatible PC connectivity and data communications applications. With Nokia Ovi Suite you can, for example, transfer files and images between your device and a compatible computer.

To use Ovi Suite with USB connection mode, select **PC Suite**.

For more information about Ovi Suite, see the support area at www.ovi.com.

About home network

Select Menu > Music > Home media.

You can use a home network to share and synchronise media files in your mobile device with other devices, such as a computer, sound system, or television. You can also view and play media files from other home network devices on your device or on other compatible devices. For example, you can play music stored in your device using a home stereo system certified by the Digital Living Network Alliance (DLNA), controlling the playlists and volume levels directly from your device.

Your device is compatible with Universal Plug and Play (UPnP) and certified by the DLNA. You can create a home network with a WLAN access point device or router. You can connect compatible WLAN enabled and DLNA certified UPnP devices to the network.

Examples of compatible devices

- Mobile device
- Compatible computer
- Television
- Sound system

- Compatible wireless multimedia receiver, connected to a sound system

You can also store your media files to a media server or retrieve media files from a compatible home server.

To use the WLAN function of your device in a home network, you must have a working WLAN home connection.

The home network uses the security settings of the WLAN connection. Use the home network feature in a WLAN infrastructure network with a WLAN access point device and encryption enabled.

13. Data management

Install or remove applications

Install applications

Select **Menu > Ctrl. panel > Data mgr. > App. mgr..**

You can transfer installation files to your device from a compatible computer, download them during browsing, or receive them in a multimedia message, as an e-mail attachment, or using other connectivity methods, such as Bluetooth connectivity. You can use Nokia Application Installer in Nokia Ovi Suite to install an application to your device.

Icons in Application manager indicate the following:



SIS or SISX application



Java™ application

! **Important:** Only install and use applications and other software from trusted sources, such as applications that are Symbian Signed or have passed the Java Verified™ testing.

Before installation, note the following:

- To view the application type, version number, and the supplier or manufacturer of the application, select **Options > View details.**

To display the security certificate details of the application, select **Details: > Certificates: > View details.**

- If you install a file that contains an update or repair to an existing application, you can only restore the original application if you have the original installation file or a full backup copy of the removed software package. To restore the original application, remove the application, and install the application again from the original installation file or the backup copy.

The JAR file is required for installing Java applications. If it is missing, the device may ask you to download it. If there is no access point defined for the application, you are asked to select one. When you are downloading the JAR file, you may need to enter a user name and password to access the server. You

obtain these from the supplier or manufacturer of the application.

To install software or an application, do the following:

1 To locate an installation file, select **Menu > Ctrl. panel > Data mgr. > App. mgr.**. Alternatively, search for installation files using File manager, or select **Messaging > Inbox**, and open a message that contains an installation file.

2 In Application manager, select **Options > Install**. In other applications, select the installation file to start the installation.

During installation, the device displays information about the progress of the installation. If you install an application without a digital signature or certification, the device displays a warning. Continue installation only if you are sure of the origin and contents of the application.

To start an installed application, locate the application in the menu, and select the application.

To see which software packages are installed or removed and when, select **Options > View log**.

 **Important:** Your device can only support one antivirus application. Having more than one application with antivirus functionality could affect performance and operation or cause the device to stop functioning.

After you install applications to a compatible memory card, installation files (.sis, .sisx) remain in the device memory. The files may use large amounts of memory and prevent you from storing other files. To maintain sufficient memory, use Nokia Ovi Suite to back up installation files to a compatible PC, then use the file manager to remove the installation files from the device memory. If the .sis file is a message attachment, delete the message from the Messaging inbox.

Remove applications and software

Select **Menu > Ctrl. panel > Data mgr. > App. mgr.**

Scroll to a software package, and select **Options** > **Uninstall**. Select **Yes** to confirm.

If you remove software, you can only reinstall it if you have the original software package or a full backup of the removed software package. If you remove a software package, you may no longer be able to open documents created with that software.

If another software package depends on the software package that you removed, the other software package may stop working. For more information, see the documentation of the installed software package.

Application manager settings

Select **Menu** > **Ctrl. panel** > **Data mgr.** > **App. mgr.**.

Select **Options** > **Settings** and from the following:

Software installation — Select whether Symbian software that has no verified digital signature can be installed.

Online certificate check — Check the online certificates before installing an application.

Default web address — Set the default address used when checking online certificates.

Some Java applications may require that a message be sent or a network connection be made to a specific access point to download extra data or components.

File manager

About File manager

Select **Menu** > **Applications** > **File mgr.**.

With File manager, you can browse, manage, and open files on your device or a compatible external drive.

Find and organise files

Select **Menu** > **Applications** > **File mgr.**.

To find a file, select **Options** > **Find**. Select where to search, and enter a search term that matches the file name.

To move or copy files and folders, or to create new folders, select **Options** > **Organise**.

Back up files to a memory card

Select **Menu** > **Applications** > **File mgr.**.

To back up files to a memory card, select the file types you want to back up, and **Options** > **Back up phone memory**. Ensure that your memory card has enough free memory for the files that you have chosen to back up.

Edit the memory card

You can format a memory card to erase the data on it, or you can protect the data on the memory card with a password.

Select **Menu** > **Applications** > **File mgr.**.

Rename or format a memory card

Select **Options** > **Memory card options** and the desired option.

Password protect a memory card

Select **Options** > **Memory card password**.

These options are available only if a compatible memory card is inserted in the device.

Device manager

Remote configuration

Select **Menu** > **Ctrl. panel** > **Data mgr.** > **Device mgr.**.

With Device manager, you can manage settings, data, and software on your device remotely.

You can connect to a server, and receive configuration settings for your device. You may receive server profiles and different configuration settings from your service providers or company information management department. Configuration settings may include connection and other settings used by different applications in your device. The available options may vary.

The remote configuration connection is usually started by the server when the device settings need to be updated.

To create a new server profile, select **Options > Server profiles > Options > New server profile**.

You may receive these settings from your service provider in a configuration message. If not, define the following:

Server name — Enter a name for the configuration server.

Server ID — Enter the unique ID to identify the configuration server.

Server password — Enter a password to identify your device to the server.

Access point — Select the access point to use for the connection, or create a new access point. You can also choose to be asked for the access point every time you start a connection. This setting is available only if you have selected **Internet** as the bearer type.

Host address — Enter the web address of the configuration server.

Port — Enter the port number of the server.

User name and Password — Enter your user ID and password for the configuration server.

Allow configuration — Select **Yes** to allow the server to initiate a configuration session.

Auto-accept all requests — Select **Yes** if you do not want the server to ask for your confirmation when it initiates a configuration session.

Network authentication — Select whether to use http authentication.

Network user name and Network password — Enter your user ID and password for the http authentication. This setting is available only if you have selected **Network authentication** to be used.

To connect to the server and receive configuration settings for your device, select **Options > Start configuration**.

To view the configuration log of the selected profile, select **Options > View log**.

To update the device software over the air, select **Options > Check for updates**. The update does not erase your settings. When you receive the update package on your device, follow the instructions on the display. Your

device is restarted once the installation is complete.

Downloading software updates may involve the transmission of large amounts of data (network service).

Make sure that the device battery has enough power, or connect the charger before starting the update.

Warning:

If you install a software update, you cannot use the device, even to make emergency calls, until the installation is completed and the device is restarted. Be sure to back up data before accepting installation of an update.

About Licenses

Select **Menu > Ctrl. panel > Data mgr. > Licenses.**

Some media files, such as images, music, or video clips, are protected by digital usage rights. The licenses for such files may allow or restrict their usage. For example, with some licenses you may listen to a song only a limited number of times. During one playback

session you may rewind, fast-forward, or pause the song, but once you stop it, you have used one of the instances allowed.

14. Settings

Application settings

Select **Menu > Ctrl. panel > Settings and Applications.**

Select an application from the list to adjust its settings.

Device and SIM card security

Select **Menu > Ctrl. panel > Settings > General > Security.**

To change the PIN code, select **Phone and SIM card > PIN code.** The new code must be 4 to 8 digits long. The PIN code protects your SIM card against unauthorised use and is provided with the SIM card. After three consecutive incorrect PIN code entries, the code is blocked, and you need to use the PUK code to unblock it before you can use the SIM card again.

To set the keypad to lock automatically after a defined period, select **Phone and SIM card > Keypad autolock period.**

To set a time-out period after which the device is automatically locked and can be used only if the correct lock code is

entered, select **Phone and SIM card > Phone autolock period.** Enter the length of the time-out period in minutes, or select **None** to deactivate the autolock feature. When the device is locked, you can still answer incoming calls, and calls may still be possible to the official emergency number programmed into your device.

To change the lock code, select **Phone and SIM card > Lock code.** The default lock code is 12345. Enter the current code and then the new code twice. The new code must be 4-255 characters long. Alphanumeric (uppercase and lowercase) characters can be used. The device notifies you if the lock code is not properly formatted.

Accessory settings

Select **Menu > Ctrl. panel > Settings and General > Enhancement.**

To define which profile is activated when you attach an accessory to your device, select the accessory and **Default profile.**

To set the device to answer phone calls automatically after 5 seconds when an accessory is attached, select the

accessory and **Automatic answer** > **On**. If the ringing type is set to **Beep once** or **Silent** in the selected profile, automatic answering is disabled.

To illuminate the device while it is attached to an accessory, select **Lights** > **On**. This option is only available for certain accessories.

Restore original settings

To restore the original device settings, select **Menu** > **Ctrl. panel** > **Settings** and **General** > **Factory settings**. To do this, you need your device lock code. After resetting, the device may take a longer time to switch on. Documents, contact information, calendar entries, and files are unaffected.

15. Find help

Support

When you want to learn more about how to use your product or you are unsure how your device should function, go to www.nokia.com/support, or using a mobile device, nokia.mobi/support. You can also select **Menu > Applications > Help > Help** in your device.

If this does not resolve your issue, do one of the following:

- Switch off the device, and remove the battery. After about a minute, replace the battery, and switch on the device.
- Restore the original factory settings.
- Update your device software.

If your issue remains unsolved, contact Nokia for repair options. Go to www.nokia-asia.com/repair. Before sending your device for repair, always back up the data in your device.

Keep your device software up to date About software updates

Software updates may include new features and enhanced functions that were not available at the time of purchase of your device. Updating the software may also improve the device performance.

To get a notification when new software is available for your device, register with My Nokia, and subscribe to notifications for text or e-mail messages. For more information, go to www.nokia.com/mynokia.

Warning:

If you install a software update, you cannot use the device, even to make emergency calls, until the installation is completed and the device is restarted. Be sure to back up data before accepting installation of an update.

Downloading software updates may involve the transmission of large amounts of data (network service).

Make sure that the device battery has enough power, or connect the charger before starting the update.

After updating your device software or applications, the instructions related to the updated applications in the user guide or helps may no longer be up to date.

Software updates over the air

Select **Menu > Ctrl. panel > SW update**.

With Software update (network service), you can check if there are updates available for your device software or applications, and download them to your device.

Downloading software updates may involve the transmission of large amounts of data (network service).

Make sure that the device battery has enough power, or connect the charger before starting the update.

Warning:

If you install a software update, you cannot use the device, even to make emergency calls, until the installation is completed and the device is restarted. Be sure to back up data before accepting installation of an update.

After updating your device software or applications using Software update, the instructions related to the updated applications in the user guide or the helps may no longer be up to date.

Select **Options** and from the following:

Start update — Download the available updates. To unmark specific updates that you do not want to download, select the updates from the list.

Update via PC — Update your device using a PC. This option replaces the Start update option when updates are only available using the Nokia Software Updater PC application.

View details — View information on an update.

View update history — View the status of previous updates.

Settings — Change the settings, such as the default access point used for downloading updates.

Disclaimer — View the Nokia licence agreement.

Update software using your PC

Nokia Software Updater is a PC application that enables you to update your device software. To update your device software, you need a compatible PC, broadband internet access, and a compatible USB data cable to connect your device to the PC.

To get more information and to download the Nokia Software Updater application, go to www.nokia-asia.com/softwareupdate.

In-device help

Your device contains instructions to help to use the applications in your device.

To open help texts from the main menu, select **Menu > Applications > Help > Help** and the application for which you want to read instructions.

When an application is open, to access the help text for the current view, select **Options > Help**.

When you are reading the instructions, to change the size of the help text, select

Options > Decrease font size or Increase font size.

You may find links to related topics at the end of the help text.

If you select an underlined word, a short explanation is displayed.

Help texts use the following indicators:



Link to a related help topic.



Link to the application being discussed.

When you are reading the instructions, to switch between help texts and the application that is open in the background, select **Options > Show open apps.** and the desired application.

Settings

Your device normally has MMS, GPRS, streaming, and mobile internet settings automatically configured, based on your network service provider information. You may have settings from your service providers already installed in your device, or you may receive or request the settings from the network service providers as a special message.

You can change the general settings in your device, such as language, standby mode, display, and keypad lock settings.

Access codes

If you forget any of the access codes, contact your service provider.

Personal identification number (PIN) code — This code protects your SIM card against unauthorised use. The PIN code (4 - 8 digits) is usually supplied with the SIM card. After three consecutive incorrect PIN code entries, the code is blocked, and you need the PUK code to unblock it.

UPIN code — This code may be supplied with the USIM card. The USIM card is an enhanced version of the SIM card and is supported by 3G mobile phones.

PIN2 code — This code (4 - 8 digits) is supplied with some SIM cards, and is required to access some functions in your device.

Lock code (also known as security code) — The lock code helps you to protect your device against unauthorised use. The preset code is 12345. You can create and change the code, and set the device to request the

code. Keep the new code secret and in a safe place separate from your device. If you forget the code and your device is locked, your device will require service. Additional charges may apply, and all the personal data in your device may be deleted. For more information, contact a Nokia Care Centre or your device dealer.

Personal Unblocking Key (PUK) code and PUK2 code — These codes (8 digits) are required to change a blocked PIN code or PIN2 code, respectively. If the codes are not supplied with the SIM card, contact the network service provider whose SIM card is in your device.

UPUK code — This code (8 digits) is required to change a blocked UPIN code. If the code is not supplied with the USIM card, contact the network service provider whose USIM card is in your device.

International Mobile Equipment Identity (IMEI) number — This number (15 or 17 digits) is used to identify valid devices on the GSM network. Devices that are, for example, stolen, can be blocked from accessing the network. The IMEI number for your device can be found under the battery.

Prolong battery life

Many features in your device increase the demand on battery power and reduce the battery lifetime. To save battery power, note the following:

- Features that use Bluetooth technology, or allowing such features to run in the background while using other features, increase the demand on battery power. Deactivate Bluetooth technology when you do not need it.
- Features that use wireless LAN (WLAN), or allowing such features to run in the background while using other features, increase the demand on battery power. WLAN on your Nokia device deactivates when you are not trying to connect, not connected to an access point, or not scanning for available networks. To further reduce battery consumption, you can specify that your device does not scan, or scans less often, for available networks in the background.
- If you have set **Packet data connection to When available** in connection settings, and there is no packet data coverage (GPRS), the

device periodically tries to establish a packet data connection. To prolong the operating time of your device, select **Menu > Ctrl. panel > Settings and Connection > Packet data > Packet data connection > When needed**.

- If the signal strength of the cellular network varies much in your area, your device must scan for the available network repeatedly. This increases the demand on battery power.

If the network mode is set to dual mode in the network settings, the device searches for the 3G network. You can set the device to use only the GSM network. To use only the GSM network, select **Menu > Ctrl. panel > Settings and Phone > Network > Network mode > GSM**.

- The backlight of the display increases the demand on battery power. In the display settings, you can change the length of the time-out period after which the backlight is switched off. Select **Menu > Ctrl. panel > Settings and General > Personalisation > Display >**

Light time-out. To adjust the light sensor that observes lighting conditions and adjusts the display brightness, in the display settings, select **Light sensor**.

- Leaving applications running in the background increases the demand on battery power. To close the applications you are not using, press and hold the menu key, scroll to the application, and press the backspace key.
- To save power, activate the power save mode. Press the power key, and select **Activate power saving**. To deactivate it, press the power key, and select **Deactivate power saving**. You may not be able to change the settings of certain applications when the power save mode is activated.

Free memory

To view how much memory is available for different data types, select **Menu > Applications > File mgr..**

Many features of the device use memory to store data. The device notifies you if available memory is low.

To free memory, transfer data to an alternative memory (if available) or compatible computer.

To remove data you no longer need, use File manager or the respective application. You can remove the following:

- Messages in the folders in Messaging and retrieved e-mail messages from the mailbox
- Saved web pages
- Contact information
- Calendar notes
- Applications shown in Application manager that you do not need
- Installation files (with .sis or .sisx file extensions) of installed applications. Back up the installation files to a compatible computer.
- Images and video clips in Photos.

16. Green tips



Save energy

You do not need to charge your battery so often if you do the following (if available for your device):

- Close applications and data connections, for example, your Bluetooth connection, when not in use.
- Decrease the brightness of the screen.
- Set your device to enter power saver mode after the minimum period of inactivity, if available in your device.
- Deactivate unnecessary sounds, such as key tones.

Recycle

All materials of this device can be recovered as materials and energy. For information on how to recycle your old Nokia products, go to www.nokia.com/

werecycle, or using a mobile device, nokia.mobi/werecycle.

Recycle packaging and user guides at your local recycling scheme.

For more information on the environmental attributes of your device, go to www.nokia.com/ecodeclaration.

Product and safety information

Accessories

Nokia original accessories



Warning:

Use only batteries, chargers, and accessories approved by Nokia for use with this particular model. The use of any other types may invalidate any approval or warranty, and may be dangerous. In particular, use of unapproved chargers or batteries may present a risk of fire, explosion, leakage, or other hazard.

For availability of approved accessories, check with your dealer.



110 Product and safety information

An extensive range of accessories is available for your device. For more details, see www.nokia-asia.com/accessories.

Practical rules about accessories

- Keep all accessories out of the reach of small children.
- When you disconnect the power cord of any accessory, grasp and pull the plug, not the cord.
- Check regularly that accessories installed in a vehicle are mounted and are operating properly.
- Installation of any complex car accessories must be made by qualified personnel only.

Battery

Type: BL-5F

Talk time:

Up to 4 hours (WCDMA) / 9 hours (GSM).

Standby

Up to 450 hours (WCDMA) / 450 hours (GSM).

 **Important:** Battery talk and stand-by times are estimates and only possible under optimal network conditions. Actual battery talk and standby times depend on SIM cards, features used, battery age and condition, temperatures to which battery is exposed, network conditions, and many other factors, and may be significantly shorter than those specified above. Ringing tones, hands free call handling, use in digital mode, and other features will also consume the battery, and the amount of time a device is used for calls will affect its stand-by time. Likewise, the amount of time that the device is turned on and in the standby mode will affect its talk time.

Battery

Battery and charger information

Your device is powered by a rechargeable battery. The battery intended for use with this device is BL-5F. Nokia may make additional battery models available for this device. This device is intended for use when supplied with power from the following chargers: AC-6. The exact charger model number may vary depending on the type of plug. The plug variant is identified by one of the following: E, EB, X, AR, U, A, C, K, or UB.

The battery can be charged and discharged hundreds of times, but it will eventually wear out. When the talk and standby times are noticeably shorter than normal, replace the battery. Use only Nokia approved batteries, and recharge your battery only with Nokia approved chargers designated for this device.

If a battery is being used for the first time or if the battery has not been used for a prolonged period, it may be necessary to connect the charger, then disconnect and reconnect it to begin charging the battery. If the battery is completely discharged, it may take several minutes before the charging indicator appears on the display or before any calls can be made.

Safe removal. Always switch the device off and disconnect the charger before removing the battery.

Proper charging. Unplug the charger from the electrical plug and the device when not in use. Do not leave a fully charged battery connected to a charger, since overcharging may shorten its lifetime. If left unused, a fully charged battery will lose its charge over time.

Avoid extreme temperatures. Always try to keep the battery between 15°C and 25°C (59°F and 77°F). Extreme temperatures reduce the capacity and lifetime of the battery. A device with a hot or cold battery may not work

temporarily. Battery performance is particularly limited in temperatures well below freezing.

Do not short-circuit. Accidental short-circuiting can occur when a metallic object such as a coin, clip, or pen causes direct connection of the positive (+) and negative (-) terminals of the battery. (These look like metal strips on the battery.) This might happen, for example, when you carry a spare battery in your pocket or purse. Short-circuiting the terminals may damage the battery or the connecting object.

Disposal. Do not dispose of batteries in a fire as they may explode. Dispose of batteries according to local regulations. Please recycle when possible. Do not dispose as household waste.

Leak. Do not dismantle, cut, open, crush, bend, puncture, or shred cells or batteries. In the event of a battery leak, prevent battery liquid contact with the skin or eyes. If this happens, flush the affected areas immediately with water, or seek medical help.

Damage. Do not modify, remanufacture, attempt to insert foreign objects into the battery, or immerse or expose it to water or other liquids. Batteries may explode if damaged.

Correct use. Use the battery only for its intended purpose. Improper battery use may result in a fire, explosion, or other hazard. If the device or battery is dropped, especially on a hard surface, and you believe the battery has been damaged, take it to a service centre for inspection before continuing to use it. Never use any charger or battery that is damaged. Keep your battery out of the reach of small children.

! **Important:** Talk and standby times are estimates only. Actual performance depends on many factors such

as network conditions, device settings selected, device features being used (or running in the background), battery condition and ambient temperature. Making calls with the device affects the standby time and the amount of time in standby mode affects the talk time.

Nokia battery authentication guidelines

Always use original Nokia batteries for your safety. To check that you are getting an original Nokia battery, purchase it from a Nokia authorised service centre or dealer, and inspect the hologram label using the following steps:

Authenticate hologram

- 1 When you look at the hologram on the label, you should see the Nokia connecting hands symbol from one angle and the Nokia Original Enhancements logo when looking from another angle.



112 Product and safety information

- 2 When you angle the hologram left, right, down and up, you should see 1, 2, 3 and 4 dots on each side respectively.



Successful completion of the steps is not a total assurance of the authenticity of the battery. If you cannot confirm authenticity or if you have any reason to believe that your Nokia battery with the hologram on the label is not an authentic Nokia battery, you should refrain from using it, and take it to the nearest Nokia authorised service centre or dealer for assistance.

To find out more about original Nokia batteries, see www.nokia.com/batterycheck

Taking care of your device

Your device is a product of superior design and craftsmanship and should be treated with care. The following suggestions will help you protect your warranty coverage.

- Keep the device dry. Precipitation, humidity, and all types of liquids or moisture can contain minerals that will corrode electronic circuits. If your device does get wet, remove the battery, and allow the device to dry completely before replacing it.
- Do not use or store the device in dusty, dirty areas. Its moving parts and electronic components can be damaged.
- Do not store the device in high or cold temperature. High temperatures can shorten the life of electronic devices, damage batteries, and warp or melt certain plastics. When the device warms to its normal temperature from a cold temperature, moisture can form inside the device and damage electronic circuit boards.
- Do not attempt to open the device other than as instructed in this guide.
- Do not drop, knock, or shake the device. Rough handling can break internal circuit boards and fine mechanics.
- Do not use harsh chemicals, cleaning solvents, or strong detergents to clean the device. Only use a soft, clean, dry cloth to clean the surface of the device.
- Do not paint the device. Paint can clog the moving parts and prevent proper operation.
- Use only the supplied or an approved replacement antenna. Unauthorised antennas, modifications, or attachments could damage the device and may violate regulations governing radio devices.
- Use chargers indoors.
- Backup all data you want to keep, such as contacts and calendar notes.
- To reset the device from time to time for optimum performance, power off the device and remove the battery.

These suggestions apply equally to your device, battery, charger, or any accessory.

Recycle

Always return your used electronic products, batteries, and packaging materials to dedicated collection points. This way you help prevent uncontrolled waste disposal and promote the recycling of materials. Check product environmental information and how to recycle your Nokia products at www.nokia.com/werecycle, or nokia.mobi/werecycle.

Additional safety information

The surface of this device is nickel-free.

Small children

Your device and its accessories are not toys. They may contain small parts. Keep them out of the reach of small children.

Operating environment

This device meets RF exposure guidelines in the normal use position at the ear or at least 1.5 centimetres (5/8 inch) away from the body. Any carry case, belt clip, or holder for body-worn operation should not contain metal and should position the device the above-stated distance from your body.

To send data files or messages requires a quality connection to the network. Data files or messages may be delayed until such a connection is available. Follow the separation distance instructions until the transmission is completed.

Parts of the device are magnetic. Metallic materials may be attracted to the device. Do not place credit cards or other magnetic storage media near the device, because information stored on them may be erased.

Medical devices

Operation of radio transmitting equipment, including wireless phones, may interfere with the function of

inadequately protected medical devices. Consult a physician or the manufacturer of the medical device to determine whether they are adequately shielded from external RF energy. Switch off your device when regulations posted instruct you to do so. Hospitals or health care facilities may use equipment sensitive to external RF energy.

Implanted medical devices

Manufacturers of medical devices recommend a minimum separation of 15.3 centimetres (6 inches) between a wireless device and an implanted medical device, such as a pacemaker or implanted cardioverter defibrillator, to avoid potential interference with the medical device. Persons who have such devices should:

- Always keep the wireless device more than 15.3 centimetres (6 inches) from the medical device.
- Not carry the wireless device in a breast pocket.
- Hold the wireless device to the ear opposite the medical device.
- Turn the wireless device off if there is any reason to suspect that interference is taking place.
- Follow the manufacturer directions for the implanted medical device.

If you have any questions about using your wireless device with an implanted medical device, consult your health care provider.

Hearing aids

Some digital wireless devices may interfere with some hearing aids.

Vehicles

RF signals may affect improperly installed or inadequately shielded electronic systems in motor vehicles such as electronic fuel injection, electronic antilock braking,

114 Product and safety information

electronic speed control, and air bag systems. For more information, check with the manufacturer of your vehicle or its equipment.

Only qualified personnel should service the device or install the device in a vehicle. Faulty installation or service may be dangerous and may invalidate your warranty. Check regularly that all wireless device equipment in your vehicle is mounted and operating properly. Do not store or carry flammable liquids, gases, or explosive materials in the same compartment as the device, its parts, or accessories. Remember that air bags inflate with great force. Do not place your device or accessories in the air bag deployment area.

Switch off your device before boarding an aircraft. The use of wireless teledevices in an aircraft may be dangerous to the operation of the aircraft and may be illegal.

Potentially explosive environments

Switch off your device in any area with a potentially explosive atmosphere. Obey all posted instructions. Sparks in such areas could cause an explosion or fire resulting in bodily injury or death. Switch off the device at refuelling points such as near gas pumps at service stations. Observe restrictions in fuel depots, storage, and distribution areas; chemical plants; or where blasting operations are in progress. Areas with a potentially explosive atmosphere are often, but not always, clearly marked. They include areas where you would be advised to turn off your vehicle engine, below deck on boats, chemical transfer or storage facilities and where the air contains chemicals or particles such as grain, dust, or metal powders. You should check with the manufacturers of vehicles using liquefied petroleum gas (such as propane or butane) to determine if this device can be safely used in their vicinity.

Emergency calls

 **Important:** This device operates using radio signals, wireless networks, landline networks, and user-programmed functions. If your device supports voice calls over the internet (internet calls), activate both the internet calls and the cellular phone. The device may attempt to make emergency calls over both the cellular networks and through your internet call provider if both are activated. Connections in all conditions cannot be guaranteed. You should never rely solely on any wireless device for essential communications like medical emergencies.

Make an emergency call

- 1 Ensure the device is switched on.
- 2 Check for adequate signal strength. You may also need to do the following:
 - Insert a SIM card.
 - Remove call restrictions you have activated for your device, such as call barring, fixed dialling, or closed user group.
 - Ensure your device is not in an offline or flight profile.
- 3 To clear the display, press the end key as many times as needed.
- 4 Enter the official emergency number for your present location. Emergency call numbers vary by location.
- 5 Open the slide, and press the call key.

When making an emergency call, give all the necessary information as accurately as possible. Your wireless device may be the only means of communication at the scene of an accident. Keep the slide open and do not end the call until given permission to do so.

Certification information (SAR)**This mobile device meets guidelines for exposure to radio waves.**

Your mobile device is a radio transmitter and receiver. It is designed not to exceed the limits for exposure to radio waves recommended by international guidelines. These guidelines were developed by the independent scientific organisation ICNIRP and include safety margins designed to assure the protection of all persons, regardless of age and health.

The exposure guidelines for mobile devices employ a unit of measurement known as the Specific Absorption Rate or SAR. The SAR limit stated in the ICNIRP guidelines is 2.0 watts/kilogram (W/kg) averaged over 10 grams of tissue. Tests for SAR are conducted using standard operating positions with the device transmitting at its highest certified power level in all tested frequency bands. The actual SAR level of an operating device can be below the maximum value because the device is designed to use only the power required to reach the network. That amount changes depending on a number of factors such as how close you are to a network base station.

The highest SAR value under the ICNIRP guidelines for use of the device at the ear is 0.73 W/kg.

Use of device accessories may result in different SAR values. SAR values may vary depending on national reporting and testing requirements and the network band. Additional SAR information may be provided under product information at www.nokia.com.

© 2010 Nokia. All rights reserved.

DECLARATION OF CONFORMITY

CE 0434 Ⓢ

Hereby, NOKIA CORPORATION declares that this RM-627 product is in compliance with the essential requirements and other relevant provisions of Directive 1999/5/EC. A copy of the Declaration of Conformity can be found at http://www.nokia.com/phones/declaration_of_conformity/.

Nokia, Nokia Connecting People, Navi, Ovi, Ovi by Nokia, Visual Radio, and Nokia Original Enhancements logo are trademarks or registered trademarks of Nokia Corporation. Nokia tune is a sound mark of Nokia Corporation. Other product and company names mentioned herein may be trademarks or tradenames of their respective owners.

Reproduction, transfer, distribution, or storage of part or all of the contents in this document in any form without the prior written permission of Nokia is prohibited. Nokia operates a policy of continuous development. Nokia reserves the right to make changes and improvements to any of the products described in this document without prior notice.



Java and all Java-based marks are trademarks or registered trademarks of Sun Microsystems, Inc.

This product is licensed under the MPEG-4 Visual Patent Portfolio License (i) for personal and noncommercial use in connection with information which has been encoded in compliance with the MPEG-4 Visual Standard by a consumer engaged in a personal and noncommercial activity and (ii) for use in connection with MPEG-4 video provided by a licensed video provider. No license is granted or shall be implied for any other use. Additional information, including that related to promotional, internal, and commercial uses, may be obtained from MPEG LA, LLC. See <http://www.mpegla.com>.

TO THE MAXIMUM EXTENT PERMITTED BY APPLICABLE LAW, UNDER NO CIRCUMSTANCES SHALL NOKIA OR ANY OF ITS LICENSORS BE RESPONSIBLE FOR ANY LOSS OF DATA OR INCOME OR ANY SPECIAL, INCIDENTAL, CONSEQUENTIAL OR INDIRECT DAMAGES HOWSOEVER CAUSED.

THE CONTENTS OF THIS DOCUMENT ARE PROVIDED "AS IS". EXCEPT AS REQUIRED BY APPLICABLE LAW, NO WARRANTIES OF ANY KIND, EITHER EXPRESS OR IMPLIED, INCLUDING, BUT NOT LIMITED TO, THE IMPLIED WARRANTIES OF MERCHANTABILITY AND FITNESS FOR A PARTICULAR PURPOSE, ARE MADE IN RELATION TO THE ACCURACY, RELIABILITY OR CONTENTS OF THIS DOCUMENT. NOKIA RESERVES THE RIGHT TO REVISE THIS DOCUMENT OR WITHDRAW IT AT ANY TIME WITHOUT PRIOR NOTICE.

Reverse engineering of software in the device is prohibited to the extent permitted by applicable law. Insofar as this user guide contains any limitations on Nokia's representations, warranties, damages and liabilities, such limitations shall likewise limit any representations, warranties, damages and liabilities of Nokia's licensors.

The third-party applications provided with your device may have been created and may be owned by persons or entities not affiliated with or related to Nokia. Nokia does not own the copyrights or intellectual property rights to the third-party applications. As such, Nokia does not take

any responsibility for end-user support, functionality of the applications, or the information in the applications or these materials. Nokia does not provide any warranty for the third-party applications. BY USING THE APPLICATIONS YOU ACKNOWLEDGE THAT THE APPLICATIONS ARE PROVIDED AS IS WITHOUT WARRANTY OF ANY KIND, EXPRESS OR IMPLIED, TO THE MAXIMUM EXTENT PERMITTED BY APPLICABLE LAW. YOU FURTHER ACKNOWLEDGE THAT NEITHER NOKIA NOR ITS AFFILIATES MAKE ANY REPRESENTATIONS OR WARRANTIES, EXPRESS OR IMPLIED, INCLUDING BUT NOT LIMITED TO WARRANTIES OF TITLE, MERCHANTABILITY OR FITNESS FOR A PARTICULAR PURPOSE, OR THAT THE APPLICATIONS WILL NOT INFRINGE ANY THIRD-PARTY PATENTS, COPYRIGHTS, TRADEMARKS, OR OTHER RIGHTS.

The availability of particular products and applications and services for these products may vary by region. Please check with your Nokia dealer for details and availability of language options. This device may contain commodities, technology or software subject to export laws and regulations from the US and other countries. Diversion contrary to law is prohibited.

FCC NOTICE

Your device may cause TV or radio interference (for example, when using a telephone in close proximity to receiving equipment). The FCC can require you to stop using your telephone if such interference cannot be eliminated. If you require assistance, contact your local service facility. This device complies with part 15 of the FCC rules. Operation is subject to the following two conditions: (1) This device may not cause harmful interference, and (2) this device must accept any interference received, including interference that may cause undesired operation. Any changes or modifications not expressly approved by Nokia could void the user's authority to operate this equipment.

Some operations and features are SIM card and/or network dependent, MMS dependent, or dependent on the

compatibility of devices and the content formats supported. Some services are subject to a separate charge.

Your device may have preinstalled bookmarks and links for third-party internet sites. You may also access other third-party sites through your device. Third-party sites are not affiliated with Nokia, and Nokia does not endorse or assume liability for them. If you choose to access such sites, you should take precautions for security or content.

/Issue 1.1 EN

Index**Symbols/Numbers**

3-D ringing tones 28

A

access codes 106

accessories

— settings 101

Active notes 80

alarm clock 78

answering calls 30

antennas 12

application settings 101

audio files

— details 70

audio messages 44

auto-update for time/date 78

autolock period 101

B

background image 28

battery

— charging 13

— inserting 10

— saving power 107

blogs 73

Bluetooth 91

— receiving data 90

— sending data 90

bookmarks 73

browser 71, 74

— bookmarks 71, 73

— browsing pages 71, 72

— cache memory 74

— security 74

— toolbar 72

C

cable connection 93

cache memory 74

calculator 81

calendar 76

— creating entries 76

— meeting requests 77

— views 77

call barring 34

call divert 33

call waiting 32

calls

— answering 30

— conference 31

— emergency 30

— internet calls 37

— making 30

— rejecting 30

— video calls	35	converting	
— voice mail	31	— currencies	82
— volume	30	— measurements	81
camera		cookies	74
— capturing images	65	currency conversions	82
— flash	65		
— image mode	65	D	
— video clips	66	data cable	93
cell broadcast		data connections	
— settings	54	— PC connectivity	93
charging the battery	13	— synchronisation	88
chat services (IM)	50	— wireless	85
clock	78	date and time	78
computer connections	93	declining calls	
See also <i>data connections</i>		See <i>rejecting calls</i>	
conference calls	31	device manager	98
connection methods		device setup	20
— Bluetooth	90	dictionary	82
connectors	9	DLNA (Digital Living Network Alliance)	94
contacts		downloads	
— copying	16	— podcasts	61
— images in	42		
— in social networks	42	E	
— managing	42	e-mail	49
— ringing tones	43	— attachments	48
— searching	21	— disconnecting	49
— synchronising	88	— general settings	49
— voice tags	42	— reading	48
contacts bar	21	— sending	44, 47

— setup 47

F

feeds, news 73

file management 97, 98

FM radio 62

G

gallery 66

general information 103

H

headset 15

help application 105

home network 94

home screen 20, 21

I

IM (instant messaging) 50

inbox, messages 46

indicators 22

installing applications 95

internet call services

— managing 37

internet calls 37

— activating 37

internet radio 63

K

keyboard 24

keyguard 14

keypad

— lock settings 101

keypad lock 14

keys and parts 9

L

lock code 101, 106

locking

— device autolock 101

— keypad 101

log 41

M

mailbox

— voice 31

measurements

— converting 81

media

— music player 56

— radio 62

memory

— clearing 108

— web cache 74

memory card 11, 98

Message reader 51

message reader 50

messages	44, 46
— cell broadcast settings	54
— settings	54
— text message settings	52
Mini Map	72
MMS (multimedia message service)	44, 53
multimedia	66
multimedia messages	44, 53
music	56, 57
music player	56, 57
— playlists	57
music search	60
muting incoming calls	30

N

network settings	84
news feeds	73
Nokia Messaging	49
Nokia original accessories	109
Nokia Ovi Player	58, 59
Nokia support information	103
notes	83

O

original settings	102
Ovi by Nokia	18
Ovi Music	59
Ovi Store	19

P

page overview	72
pairing devices	91
personalising your device	20, 27
photos	
— organising files	67
pictures	
— copying	16
PIN code	106
— changing	101
PIN2 code	106
playing	
— messages	50
— video and audio	69
podcasting	56, 58, 61
predictive text input	25
profiles	
— creating	27
— personalising	27
— selecting ringing tones	28
PUK codes	106

R

radio	62
RealPlayer	
— playing media clips	69
— settings	70
— viewing clip details	70
rejecting calls	30

122 Index

remote configuration	98	— podcasting	61
restoring original settings	102	— RealPlayer	70
ringing tones		— restoring	102
— 3-D	28	— service messages	54
— in profiles	28	— text messages	52
roaming	84	Settings wizard	20
S		Share online	67
Say and Play	60	— activating services	68
screen saver	28	— creating posts	68
search		— posting	68
— music	60	— subscribing	68
searching	26	shared video	38
— contacts	21	sharing media files online	67
security		shortcuts	17
— browser	74	SIM card	
— device and SIM card	101	— inserting	10
security code	106	SMS (short message service)	44
sending		software	
— using Bluetooth	90	— updating	104
service messages		software updates	103, 105
— settings	54	songs	56
settings		Speech	51
— accessories	101	speed dialling	32
— applications	101	support	103
— cell broadcast	54	switch the device off	12
— keypad lock	101	switch the device on	12
— messages	53	synchronisation	88
— network	84		

T

text	
— predictive input	25
text input	24
text messages	46
— sending	44
— settings	52
themes	28
time and date	78
transferring content	16, 20
transferring music	58

U

updates	105
UPIN code	106
— changing	101
uploading media files	67
UPUK code	106
USB data cable	93
useful information	103

V

video	
— shared	38, 39
video calls	35, 36
video centre	
— find and view videos	69
— internet videos	69
— play downloaded videos	69

video clips	
— details	70
— playing	69
— shared	38
video sharing	
— sharing live video	39
— sharing video clips	39
videos	
— copying	16
voice commands	34
voice mail	31
volume control	15

W

WLAN	
— access points	86
— availability	86
WLAN (wireless local area network)	85
WLAN wizard	86
wrist strap	16

Z

Zip manager	82
-------------	----